

## 16-Bit, Single-Ended Analog Input/Output Stereo Audio Codec

### FEATURES

- **Monolithic 16-Bit  $\Delta\Sigma$  ADC and DAC**
- **Stereo ADC:**
  - Single-Ended Voltage Input
  - Antialiasing Filter
  - 64 $\times$  Oversampling
  - High Performance
    - THD+N: –84 dB
    - SNR: 89 dB
    - Dynamic Range: 89 dB
  - Digital High-Pass Filter
- **Stereo DAC:**
  - Single-Ended Voltage Output
  - Analog Low-Pass Filter
  - 8 $\times$  Oversampling Digital Filter
  - High Performance
    - THD+N: –84 dB
    - SNR: 93 dB
    - Dynamic Range: 93 dB
- **Special Features**
  - Digital De-Emphasis
  - Power Down: ADC/DAC Independent
- **Sampling Rate: 4 kHz to 48 kHz**
- **System Clock: 256  $f_s$ , 384  $f_s$ , 512  $f_s$**
- **Single 3-V Power Supply**
- **Small Package: 24-Lead TSSOP**

### APPLICATIONS

- Sampling Keyboards
- Digital Mixers
- Effects Processors
- Hard-Disk Recorders
- Data Recorders
- Digital Video Cameras

### DESCRIPTION

The PCM3006 is a low-cost, single-chip stereo audio codec (analog-to-digital and digital-to-analog converters) with single-ended analog voltage input and output.

Both ADCs and DACs employ delta-sigma modulation with 64-times oversampling. The ADCs include a digital decimation filter, and the DACs include an 8-times oversampling digital interpolation filter. The DACs also include a digital de-emphasis function. The PCM3006 operates with 16-bit, left-justified for ADC, right-justified for DAC data formats.

The PCM3006 provides a power-down mode that operates on the ADCs and DACs independently.

The PCM3006 is fabricated using a highly advanced CMOS process, and is available in a small 24-pin TSSOP package. The PCM3006 is suitable for a wide variety of cost-sensitive consumer applications where good performance is required.

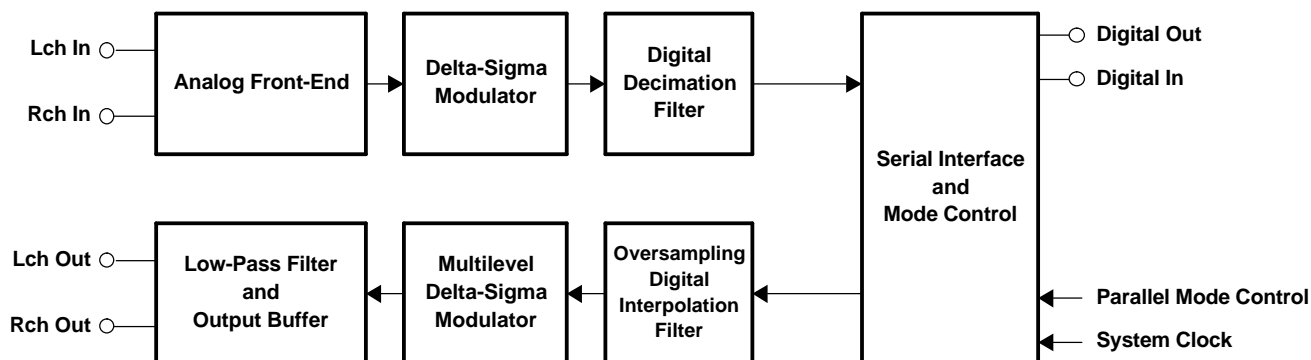

B0006-02



Please be aware that an important notice concerning availability, standard warranty, and use in critical applications of Texas Instruments semiconductor products and disclaimers thereto appears at the end of this data sheet.

System Two, Audio Precision are trademarks of Audio Precision, Inc.  
All other trademarks are the property of their respective owners.



This integrated circuit can be damaged by ESD. Texas Instruments recommends that all integrated circuits be handled with appropriate precautions. Failure to observe proper handling and installation procedures can cause damage.

ESD damage can range from subtle performance degradation to complete device failure. Precision integrated circuits may be more susceptible to damage because very small parametric changes could cause the device not to meet its published specifications.

## ELECTRICAL CHARACTERISTICS

All specifications at  $T_A = 25^\circ\text{C}$ ,  $V_{DD} = V_{CC} = 3\text{ V}$ ,  $f_S = 44.1\text{ kHz}$ ,  $\text{SYSCLK} = 384 f_S$ , and 16-bit data, unless otherwise noted

PARAMETER	CONDITIONS	PCM3006T			UNITS	
		MIN	TYP	MAX		
<b>DIGITAL INPUT/OUTPUT</b>						
<b>Input Logic</b>						
$V_{IH}^{(1)}$	Input logic level		0.7 $V_{DD}$		VDC	
$V_{IL}^{(1)}$			0.3 $V_{DD}$			
$I_{IN}^{(2)}$	Input logic current		$\pm 1$		$\mu\text{A}$	
$I_{IN}^{(3)}$			100			
<b>Output Logic</b>						
$V_{OH}^{(4)}$	Output logic level	$I_{OUT} = -1\text{ mA}$	$V_{DD} - 0.3$		VDC	
$V_{OL}^{(4)}$		$I_{OUT} = 1\text{ mA}$	0.3			
<b>CLOCK FREQUENCY</b>						
$f_S$	Sampling frequency		4	44.1	48	kHz
	System clock frequency	256 $f_S$	1.024	11.2896	12.288	MHz
		384 $f_S$	1.536	16.9344	18.432	
		512 $f_S$	2.048	22.5792	24.576	
<b>ADC CHARACTERISTICS</b>						
<b>Resolution</b>			16		Bits	
<b>DC Accuracy</b>						
Gain mismatch, channel-to-channel			$\pm 1$	$\pm 3$	% of FSR	
Gain error			$\pm 2$	$\pm 5$	% of FSR	
Gain drift			$\pm 20$		ppm of FSR/ $^\circ\text{C}$	
<b>Dynamic Performance<sup>(5)</sup></b>						
THD+N		$V_{IN} = -0.5\text{ dB}$	-84	-77	dB	
		$V_{IN} = -60\text{ dB}$	-26			
Dynamic range	A-weighted	84	89		dB	
Signal-to-noise ratio	A-weighted	84	89		dB	
Channel separation		82	86		dB	
<b>Digital Filter Performance</b>						
Pass band			0.454 $f_S$		Hz	
Stop band		0.583 $f_S$			Hz	
Pass-band ripple			$\pm 0.05$		dB	
Stop-band attenuation		-65			dB	
Delay time			17.4/ $f_S$		s	

(1) Pins 7, 8, 9, 10, 11, 15, 17, 18:  $\overline{\text{PDAD}}$ ,  $\overline{\text{PDDA}}$ ,  $\text{SYSCLK}$ ,  $\text{LRCIN}$ ,  $\text{BCKIN}$ ,  $\text{DIN}$ ,  $\text{DEM1}$ ,  $\text{DEM0}$  (Schmitt-trigger input with 100-k $\Omega$  typical internal pulldown resistor)

(2) Pins 9, 10, 11, 15:  $\text{SYSCLK}$ ,  $\text{LRCIN}$ ,  $\text{BCKIN}$ ,  $\text{DIN}$  (Schmitt-trigger input)

(3) Pins 7, 8, 17, 18:  $\overline{\text{PDAD}}$ ,  $\overline{\text{PDDA}}$ ,  $\text{DEM1}$ ,  $\text{DEM0}$  (Schmitt-trigger input, 100-k $\Omega$  typical internal pulldown resistor)

(4) Pin 12:  $\text{DOUT}$

(5)  $f_{IN} = 1\text{ kHz}$ , using System Two™ audio measurement system by Audio Precision™, rms mode with 20-kHz LPF, 400-Hz HPF used for performance calculation.

**ELECTRICAL CHARACTERISTICS (continued)**

All specifications at  $T_A = 25^\circ\text{C}$ ,  $V_{DD} = V_{CC} = 3\text{ V}$ ,  $f_S = 44.1\text{ kHz}$ ,  $\text{SYSCLK} = 384 f_S$ , and 16-bit data, unless otherwise noted

PARAMETER	CONDITIONS	PCM3006T			UNITS
		MIN	TYP	MAX	
HPF frequency response	-3 dB	0.019 $f_S$			mHz
<b>Analog Input</b>					
Voltage range		0.6 $V_{CC}$			Vp-p
Center voltage		0.5 $V_{CC}$			VDC
Input impedance		30			k $\Omega$
Antialiasing filter frequency response	-3 dB	150			kHz
<b>DAC CHARACTERISTICS</b>					
Resolution		16			Bits
<b>DC Accuracy</b>					
Gain mismatch, channel-to-channel		$\pm 1$	3		% of FSR
Gain error		$\pm 1$	5		% of FSR
Gain drift		$\pm 20$			ppm of FSR/ $^\circ\text{C}$
Bipolar zero error		$\pm 2.5$			% of FSR
Bipolar zero drift		$\pm 20$			ppm of FSR/ $^\circ\text{C}$
<b>Dynamic Performance<sup>(6)</sup></b>					
THD+N	$V_{OUT} = 0\text{ dB (full scale)}$	-84	-77		dB
	$V_{OUT} = -60\text{ dB}$	-30			
Dynamic range	EIAJ, A-weighted	86	93		dB
Signal-to-noise ratio	EIAJ, A-weighted	86	93		dB
Channel separation		84	90		dB
<b>Digital Filter Performance</b>					
Pass band		0.445 $f_S$			Hz
Stop band		0.555 $f_S$			Hz
Pass-band ripple		$\pm 0.17$			dB
Stop-band attenuation		-35			dB
Delay time		11.1/ $f_S$			s
<b>Analog Output</b>					
Voltage range		0.6 $V_{CC}$			Vp-p
Center voltage		0.5 $V_{CC}$			VDC
Load impedance	AC coupling	10			k $\Omega$
LPF frequency response	$f = 20\text{ kHz}$	-0.16			dB

(6)  $f_{OUT} = 1\text{ kHz}$ , using System Two audio measurement system by Audio Precision, rms mode with 20-kHz LPF, 400-Hz HPF used for performance calculation.

**ELECTRICAL CHARACTERISTICS (continued)**

All specifications at  $T_A = 25^\circ\text{C}$ ,  $V_{DD} = V_{CC} = 3\text{ V}$ ,  $f_S = 44.1\text{ kHz}$ ,  $\text{SYSCLK} = 384\text{ f}_S$ , and 16-bit data, unless otherwise noted

PARAMETER	CONDITIONS	PCM3006T			UNITS
		MIN	TYP	MAX	
<b>POWER SUPPLY REQUIREMENTS</b>					
$V_{CC}$ , $V_{DD}$ Voltage range	$-25^\circ\text{C}$ to $85^\circ\text{C}$	2.7	3	3.6	VDC
	$0^\circ\text{C}$ to $70^\circ\text{C}$ <sup>(7)</sup>	2.4	3	3.6	
Supply current	ADC/DAC operation, $V_{CC} = V_{DD} = 3\text{ V}$		18	24	mA
	ADC operation, $V_{CC} = V_{DD} = 3\text{ V}$		12	16	
	DAC operation, $V_{CC} = V_{DD} = 3\text{ V}$		7	10	
	ADC/DAC power down <sup>(8)</sup> , $V_{CC} = V_{DD} = 3\text{ V}$		50		$\mu\text{A}$
Power dissipation	ADC/DAC operation, $V_{CC} = V_{DD} = 3\text{ V}$		54	72	mW
	ADC operation, $V_{CC} = V_{DD} = 3\text{ V}$		36	48	
	DAC operation, $V_{CC} = V_{DD} = 3\text{ V}$		21	30	
	ADC/DAC power down <sup>(8)</sup> , $V_{CC} = V_{DD} = 3\text{ V}$		150		$\mu\text{W}$
<b>TEMPERATURE RANGE</b>					
$T_A$ Operation		-25		85	$^\circ\text{C}$
$T_{\text{stg}}$ Storage		-55		125	
$\theta_{JA}$ Thermal resistance			100		$^\circ\text{C}/\text{W}$

(7) Applies for voltages between 2.4 V and 2.7 V, for  $0^\circ\text{C}$  to  $70^\circ\text{C}$ , and 256- $f_S$ /512- $f_S$  operation (384- $f_S$  not available)

(8) SYSCLK, BCKIN, and LRCIN are stopped.

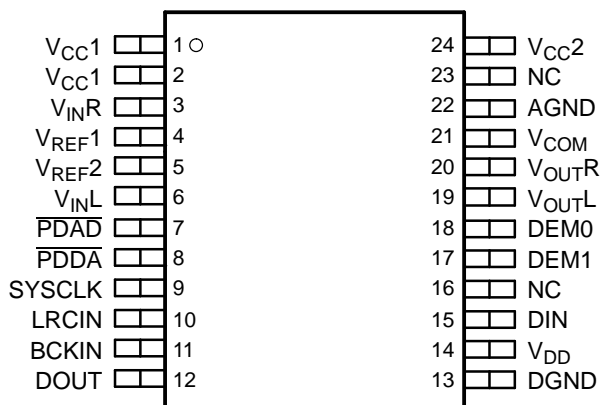
**PIN CONFIGURATION****PCM3006  
(TOP VIEW)**

NC = No Connection

P0006-01

**PIN ASSIGNMENTS**

NAME	PIN	I/O	DESCRIPTION
AGND	22	–	Analog ground
BCKIN	11	I	Bit clock input <sup>(1)</sup>
DEM0	18	I	De-emphasis control 0 <sup>(1)(2)</sup>
DEM1	17	I	De-emphasis control 1 <sup>(1)(2)</sup>
DGND	13	–	Digital ground
DIN	15	I	Data input <sup>(1)</sup>
DOUT	12	O	Data output
LRCIN	10	I	Sample rate clock input ( $f_s$ ) <sup>(1)</sup>
NC	16, 23	–	No connection
$\overline{\text{PDAD}}$	7	I	ADC power down, active LOW <sup>(1)(2)</sup>
$\overline{\text{PDDA}}$	8	I	DAC power down, active LOW <sup>(1)(2)</sup>
SYSCLK	9	I	System clock input <sup>(1)</sup>
V <sub>CC1</sub>	1, 2	–	ADC analog power supply
V <sub>CC2</sub>	24	–	DAC analog power supply
V <sub>COM</sub>	21	–	ADC/DAC common
V <sub>DD</sub>	14	–	Digital power supply
V <sub>INL</sub>	6	I	ADC analog input, Lch
V <sub>INR</sub>	3	I	ADC analog input, Rch
V <sub>OUTL</sub>	19	O	DAC analog output, Lch
V <sub>OUTR</sub>	20	O	DAC analog output, Rch
V <sub>REF1</sub>	4	–	ADC reference, 1
V <sub>REF2</sub>	5	–	ADC reference, 2

(1) Schmitt-trigger input

(2) With 100-k $\Omega$  typical internal pulldown resistor

**ABSOLUTE MAXIMUM RATINGS**

Supply voltage: $V_{DD}$ , $V_{CC1}$ , $V_{CC2}$	–0.3 V to 6.5 V
Supply voltage differences	$\pm 0.1$ V
GND voltage differences	$\pm 0.1$ V
Digital input voltage	–0.3 V to $V_{DD} + 0.3$ V, < 6.5 V
Analog input voltage	–0.3 to $V_{CC1}$ , $V_{CC2} + 0.3$ V, < 6.5 V
Power dissipation	300 mW
Input current (any pins except supplies)	$\pm 10$ mA
Operating temperature	–25°C to 85°C
Storage temperature	–55°C to 125°C
Lead temperature, soldering	260°C, 5 s
Package temperature (IR reflow, peak)	235°C

**RECOMMENDED OPERATING CONDITIONS**

over operating free-air temperature range

	MIN	NOM	MAX	UNIT	
Analog supply voltage, $V_{CC1}$ , $V_{CC2}$	2.7	3	3.6	V	
Digital supply voltage, $V_{DD}$	2.7	3	3.6	V	
Analog input voltage, full scale (–0 db)	$V_{CC} = 3$ V		1.8	Vp-p	
Digital input logic family	CMOS				
Digital input clock frequency	System clock		8.192	24.576	MHz
	Sampling clock		32	48	kHz
Analog output load resistance	10			k $\Omega$	
Analog output load capacitance	30			pF	
Digital output load capacitance	10			pF	
Operating free-air temperature, $T_A$	–25		85	°C	

**PACKAGE/ORDERING INFORMATION**

PRODUCT	PACKAGE	PACKAGE CODE	PACKAGE MARKING	ORDERING NUMBER	TRANSPORT MEDIA	QUANTITY
PCM3006T	24-pin TSSOP	DCV	PCM3006T	PCM3006T	Rails	128
				PCM3006T/2K	Tape and reel	2000

## TYPICAL PERFORMANCE CURVES

All specifications at  $T_A = 25^\circ\text{C}$ ,  $V_{CC} = V_{DD} = 3\text{ V}$ ,  $f_S = 44.1\text{ kHz}$ ,  $f_{\text{SYSCLK}} = 384 f_S$ , and  $f_{\text{SIGNAL}} = 1\text{ kHz}$ , unless otherwise noted

### ADC SECTION

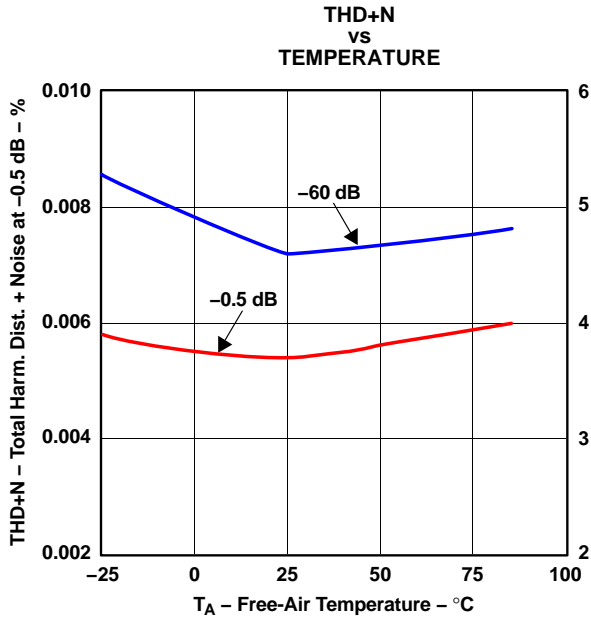

Figure 1.

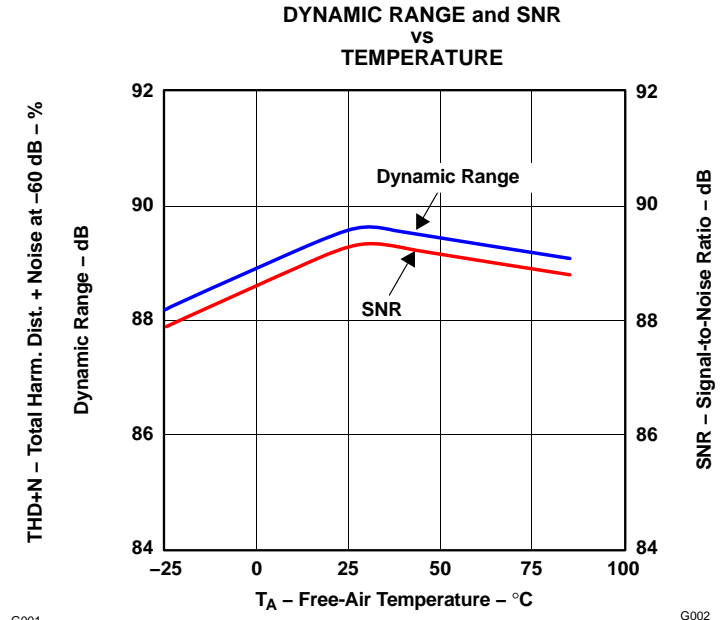

Figure 2.

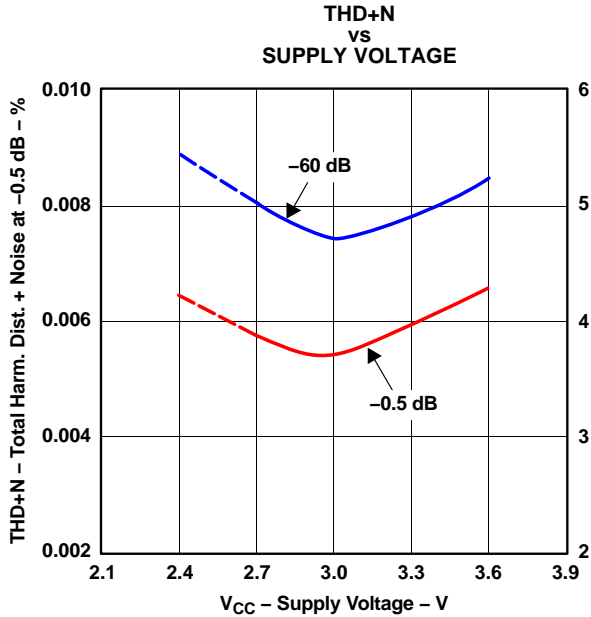

Figure 3.

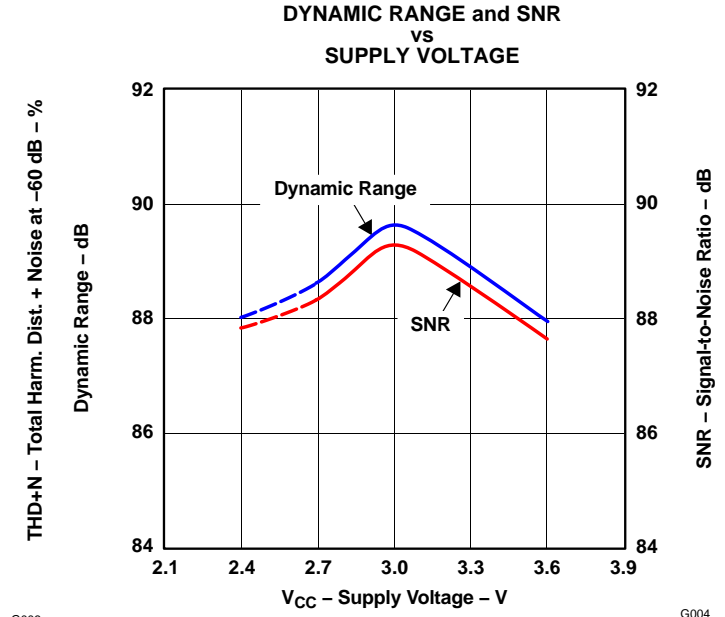

Figure 4.

NOTE: All characteristics at supply voltages from 2.4 V to 2.7 V are measured at  $\text{SYSCLK} = 256 f_S$ .

**TYPICAL PERFORMANCE CURVES (continued)**

All specifications at  $T_A = 25^\circ\text{C}$ ,  $V_{CC} = V_{DD} = 3\text{ V}$ ,  $f_S = 44.1\text{ kHz}$ ,  $f_{\text{SYSCLK}} = 384 f_S$ , and  $f_{\text{SIGNAL}} = 1\text{ kHz}$ , unless otherwise noted

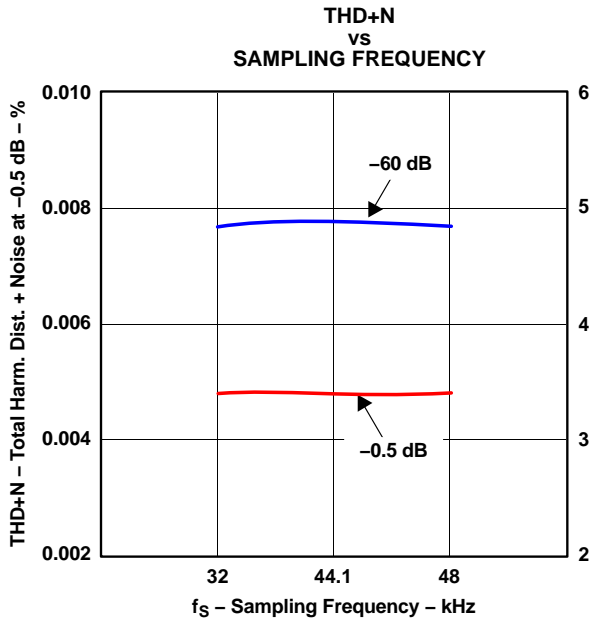

Figure 5.

G005

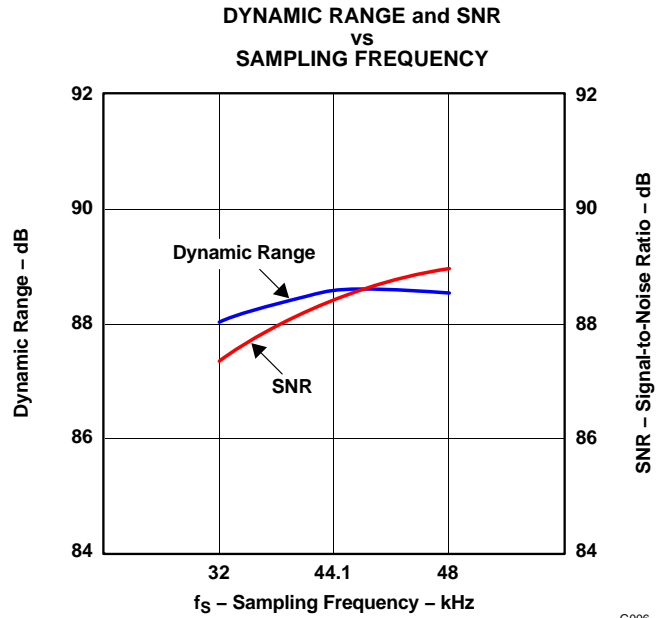

Figure 6.

G006

**DAC SECTION**

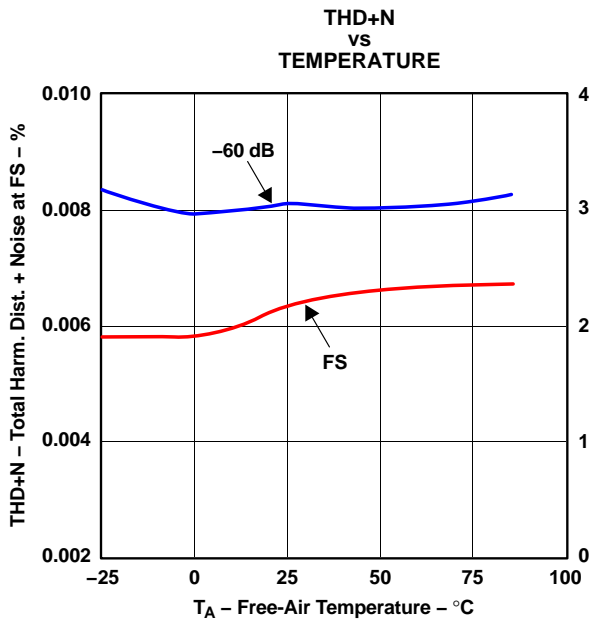

Figure 7.

G007

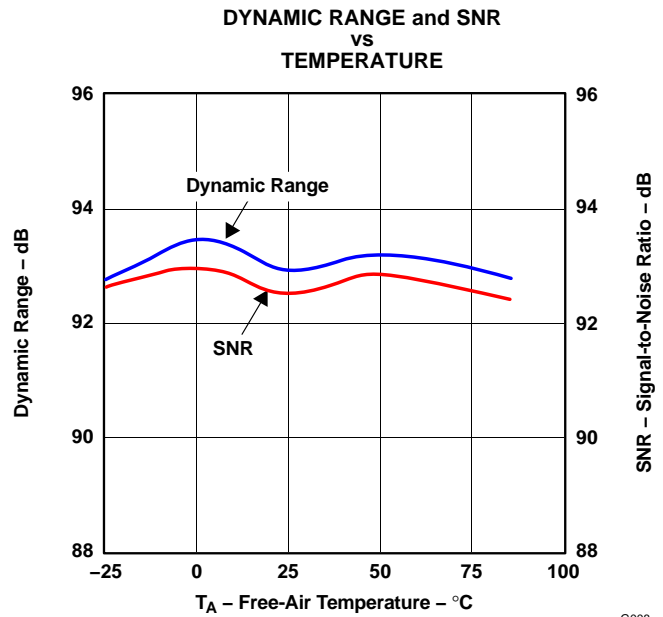

Figure 8.

G008



### TYPICAL PERFORMANCE CURVES (continued)

All specifications at  $T_A = 25^\circ\text{C}$ ,  $V_{CC} = V_{DD} = 3\text{ V}$ ,  $f_S = 44.1\text{ kHz}$ ,  $f_{\text{SYSCLK}} = 384\text{ f}_S$ , and  $f_{\text{SIGNAL}} = 1\text{ kHz}$ , unless otherwise noted

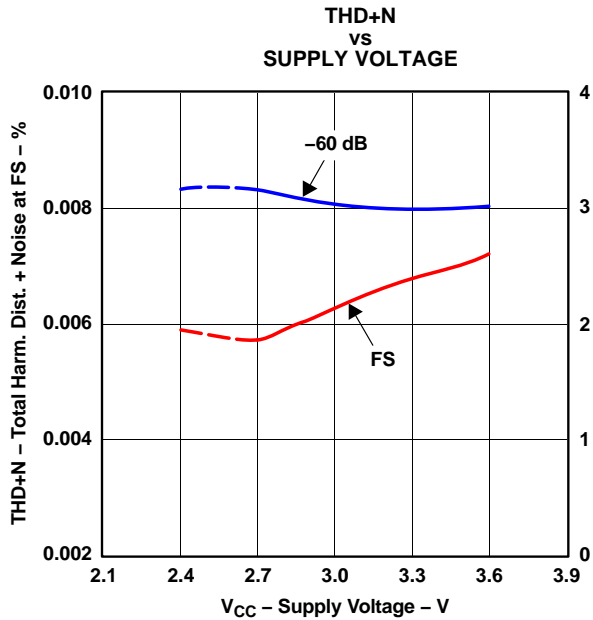

Figure 9.

G009

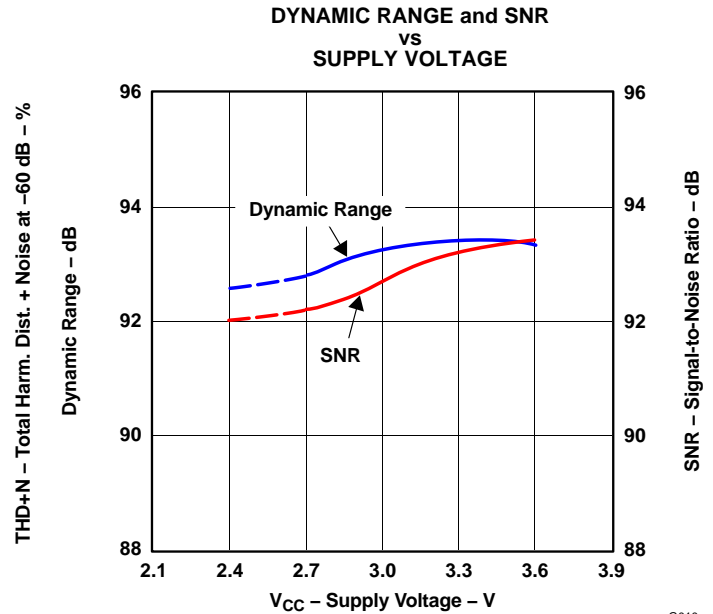

Figure 10.

G010

NOTE: All characteristics at supply voltages from 2.4 V to 2.7 V are measured at  $\text{SYSCLK} = 256\text{ f}_S$ .

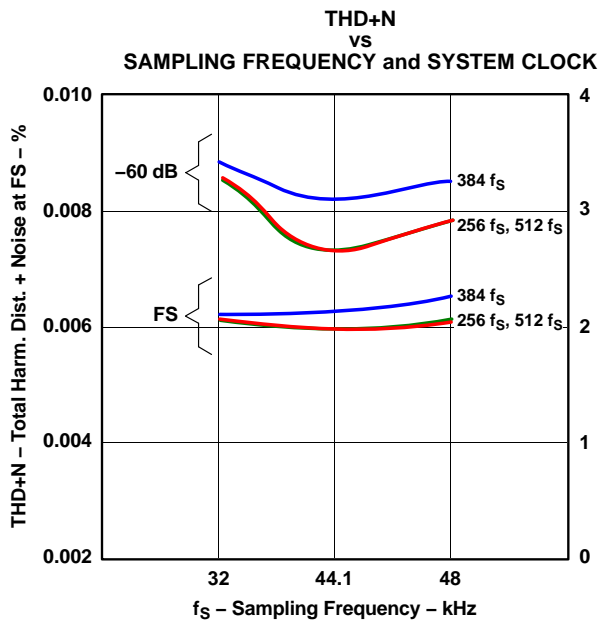

Figure 11.

G011

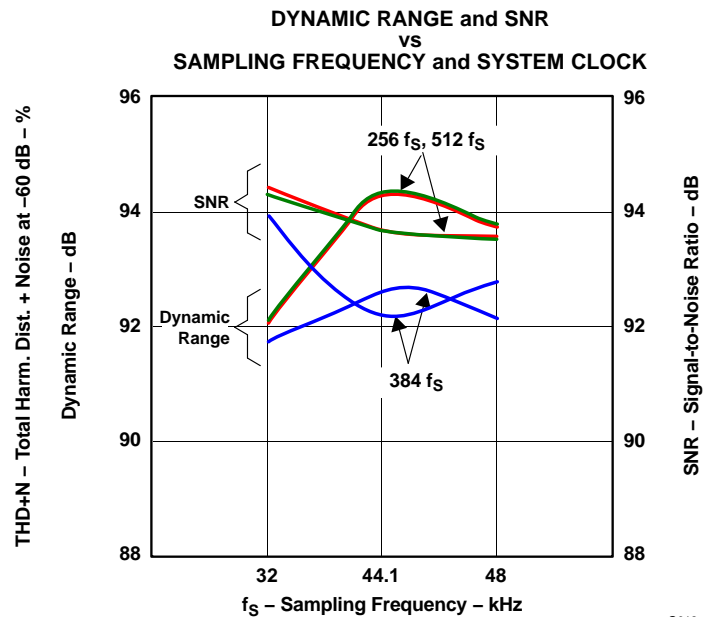

Figure 12.

G012

### TYPICAL PERFORMANCE CURVES OF INTERNAL FILTERS (ADCs)

All specifications at  $T_A = 25^\circ\text{C}$ ,  $V_{CC} = V_{DD} = 3\text{ V}$ ,  $f_s = 44.1\text{ kHz}$ , and  $f_{\text{SYSCLK}} = 384 f_s$ , unless otherwise noted

#### DECIMATION FILTER

OVERALL CHARACTERISTICS

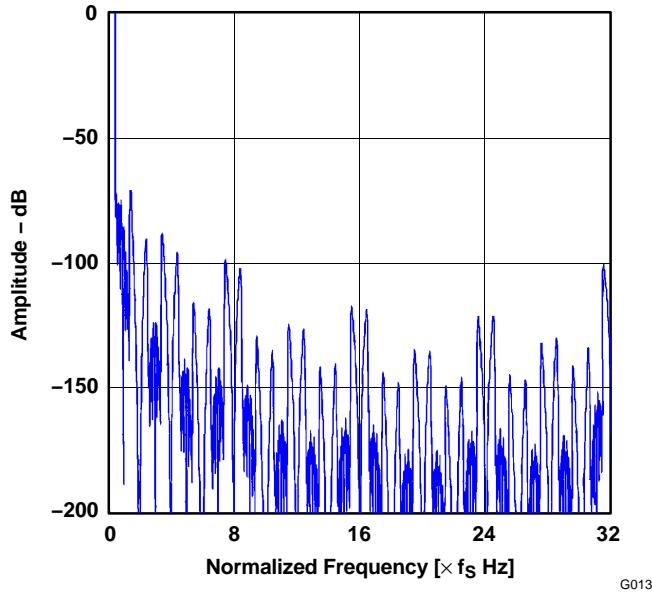

Figure 13.

STOP-BAND ATTENUATION CHARACTERISTICS

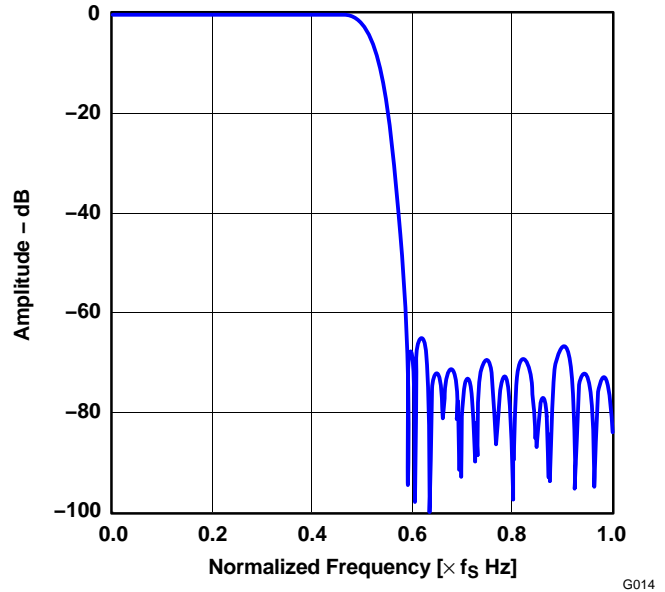

Figure 14.

PASS-BAND RIPPLE CHARACTERISTICS

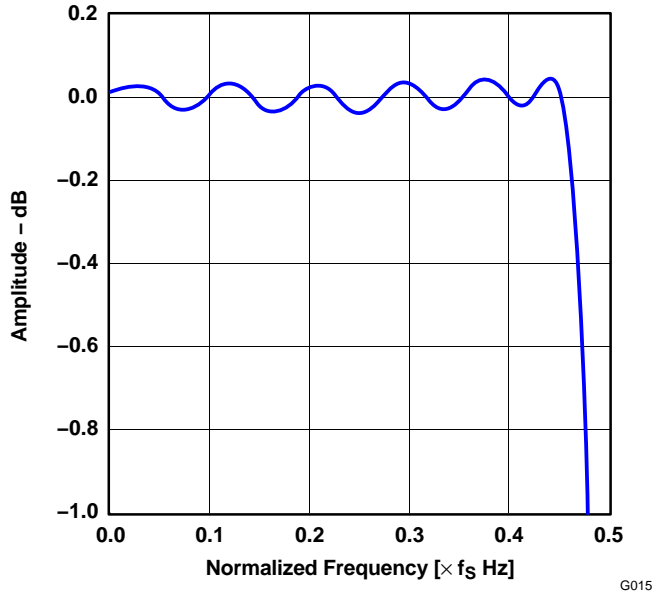

Figure 15.

TRANSITION BAND CHARACTERISTICS

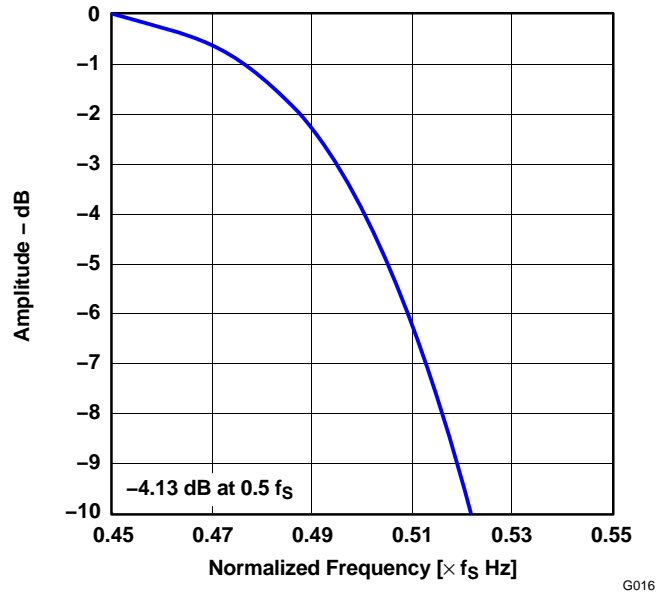

Figure 16.

**TYPICAL PERFORMANCE CURVES OF INTERNAL FILTERS (ADCs) (continued)**

All specifications at  $T_A = 25^\circ\text{C}$ ,  $V_{CC} = V_{DD} = 3\text{ V}$ ,  $f_S = 44.1\text{ kHz}$ , and  $f_{\text{SYSCLK}} = 384 f_S$ , unless otherwise noted

**HIGH-PASS FILTER**

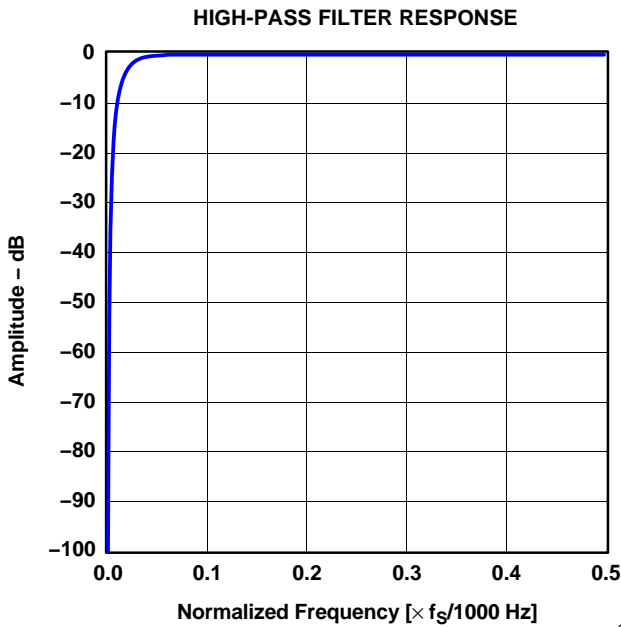

Figure 17.

G017

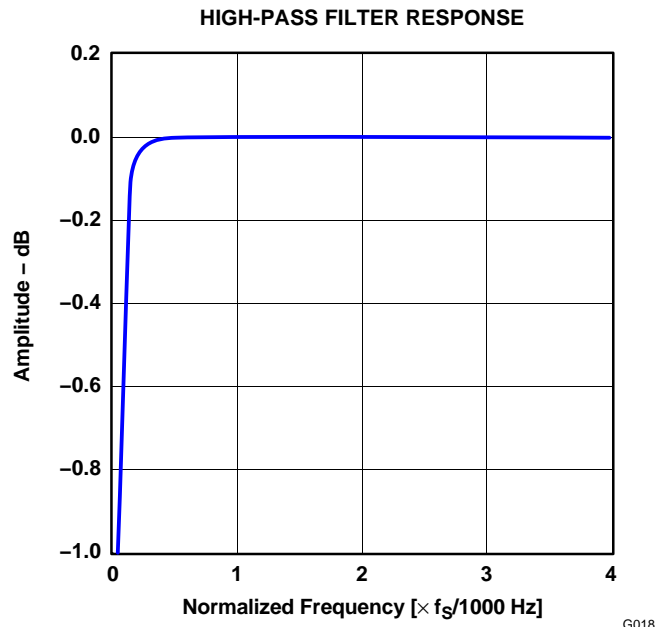

Figure 18.

G018

**ANTI\_ALIASING FILTER**

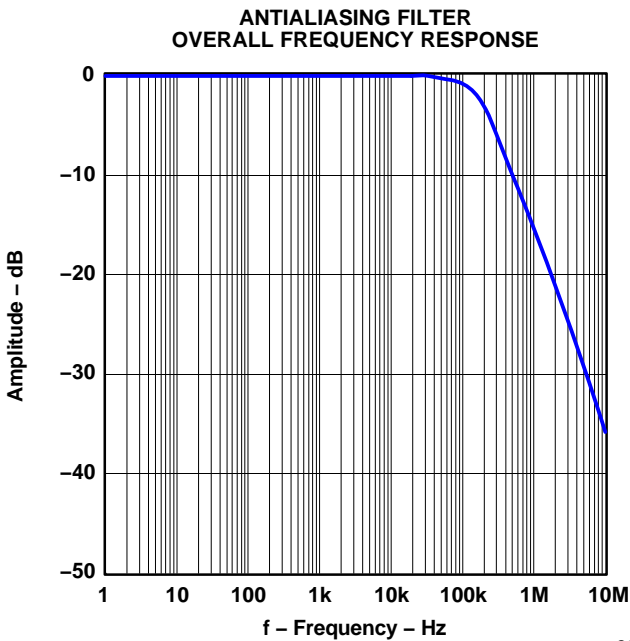

Figure 19.

G019

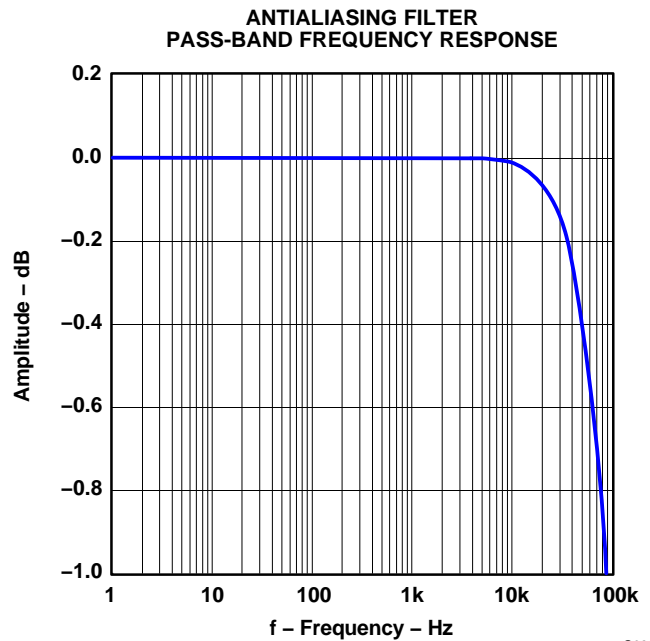

Figure 20.

G020

### TYPICAL PERFORMANCE CURVES OF INTERNAL FILTERS (DACs)

All specifications at  $T_A = 25^\circ\text{C}$ ,  $V_{CC} = V_{DD} = 3\text{ V}$ ,  $f_S = 44.1\text{ kHz}$ , and  $f_{\text{SYSCLK}} = 384 f_S$ , unless otherwise noted

#### DIGITAL FILTER

OVERALL FREQUENCY CHARACTERISTICS  
( $f_S = 44.1\text{ kHz}$ )

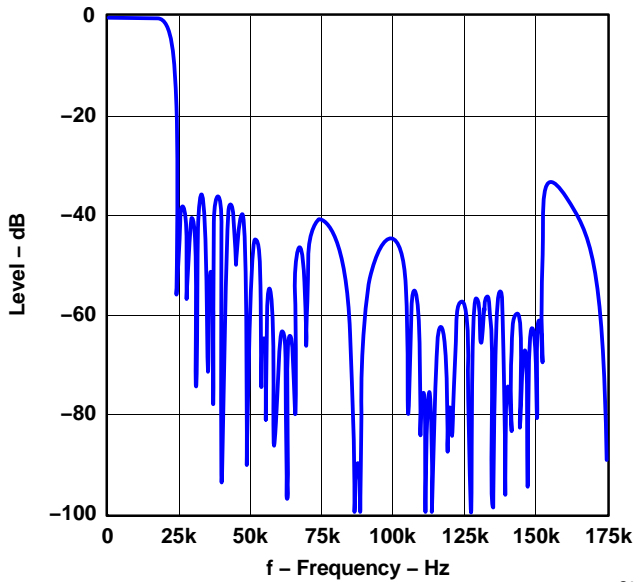

Figure 21.

PASS-BAND RIPPLE CHARACTERISTICS  
( $f_S = 44.1\text{ kHz}$ )

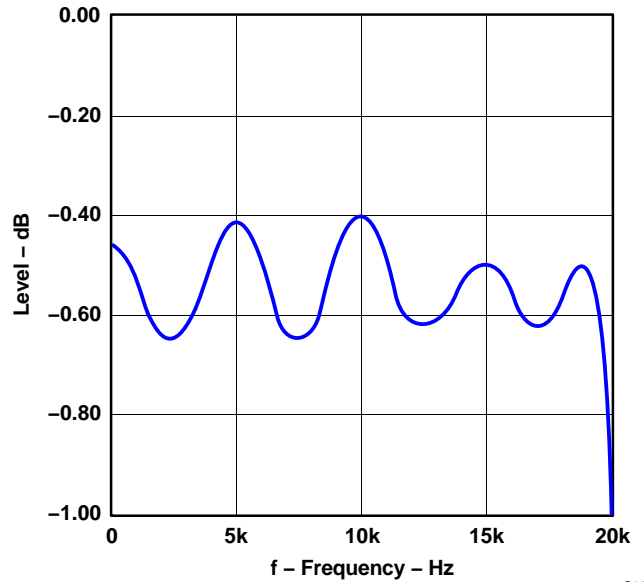

Figure 22.

#### DE-EMPHASIS FILTER

DE-EMPHASIS FREQUENCY RESPONSE (32 kHz)

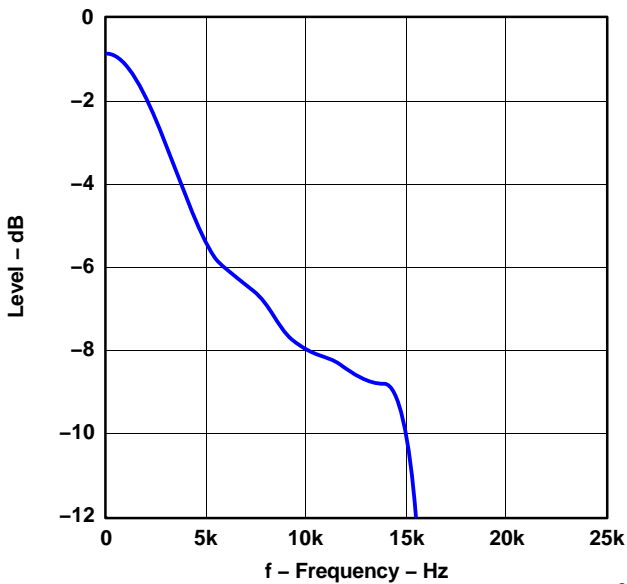

Figure 23.

DE-EMPHASIS ERROR (32 kHz)

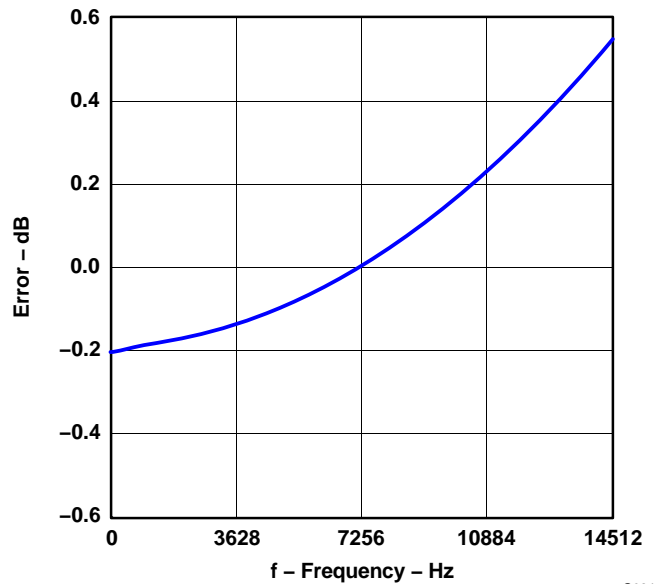

Figure 24.

**TYPICAL PERFORMANCE CURVES OF INTERNAL FILTERS (DACs) (continued)**

All specifications at  $T_A = 25^\circ\text{C}$ ,  $V_{CC} = V_{DD} = 3\text{ V}$ ,  $f_S = 44.1\text{ kHz}$ , and  $f_{\text{SYSCLK}} = 384 f_S$ , unless otherwise noted

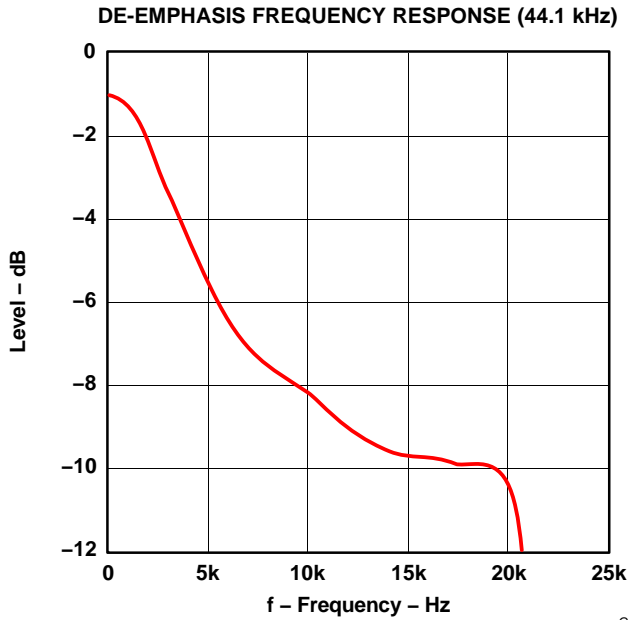

Figure 25.

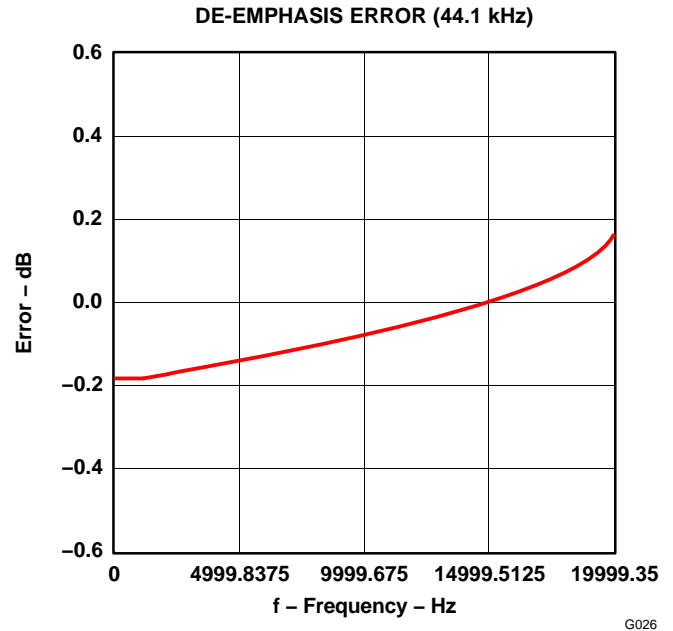

Figure 26.

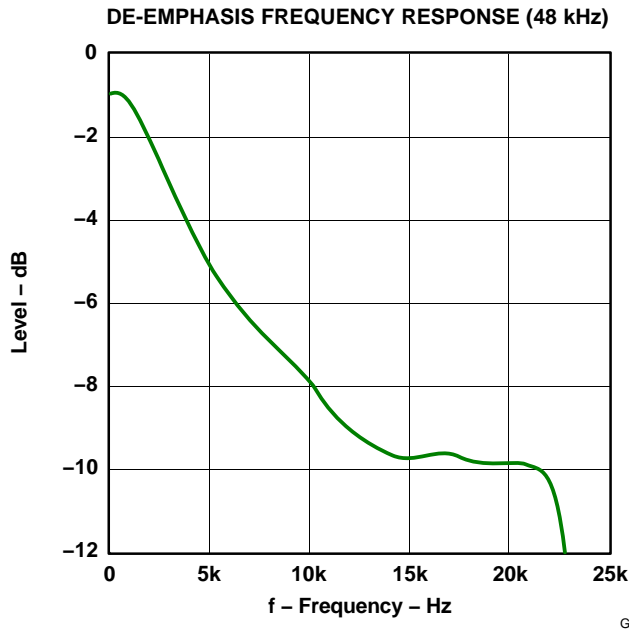

Figure 27.

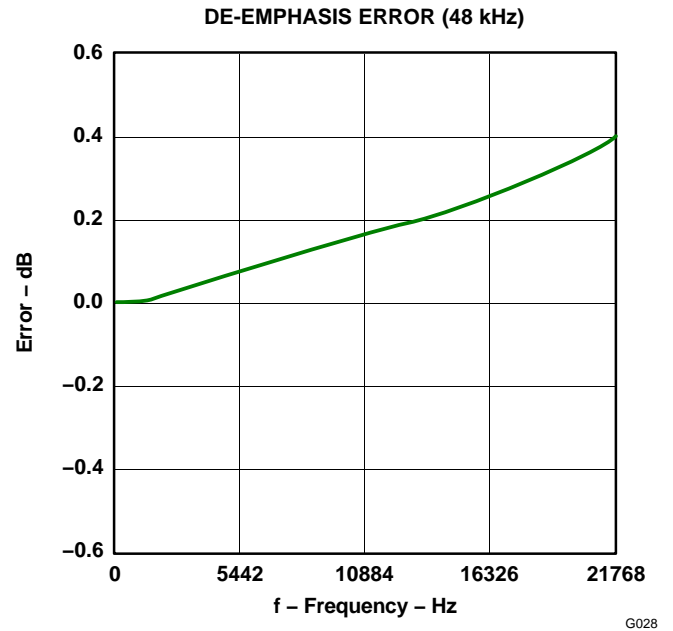

Figure 28.

**TYPICAL PERFORMANCE CURVES OF INTERNAL FILTERS (DACs) (continued)**

All specifications at  $T_A = 25^\circ\text{C}$ ,  $V_{CC} = V_{DD} = 3\text{ V}$ ,  $f_S = 44.1\text{ kHz}$ , and  $f_{\text{SYSCLK}} = 384 f_S$ , unless otherwise noted

**ANALOG LOW-PASS FILTER**

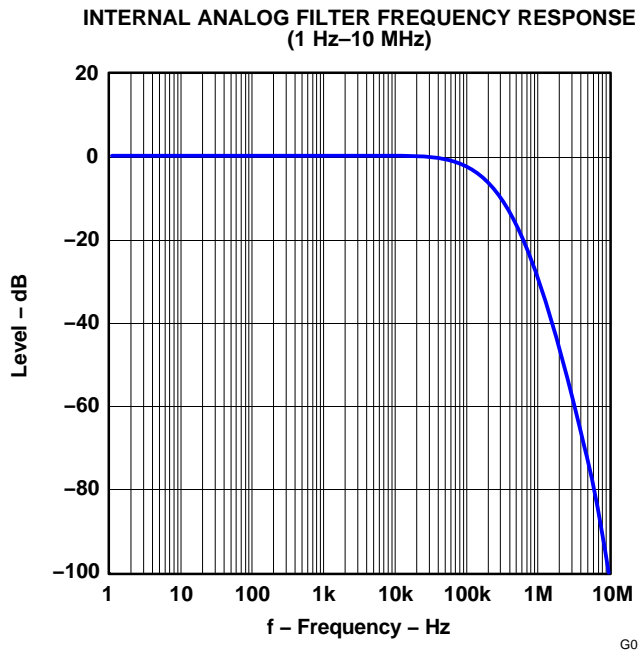

Figure 29.

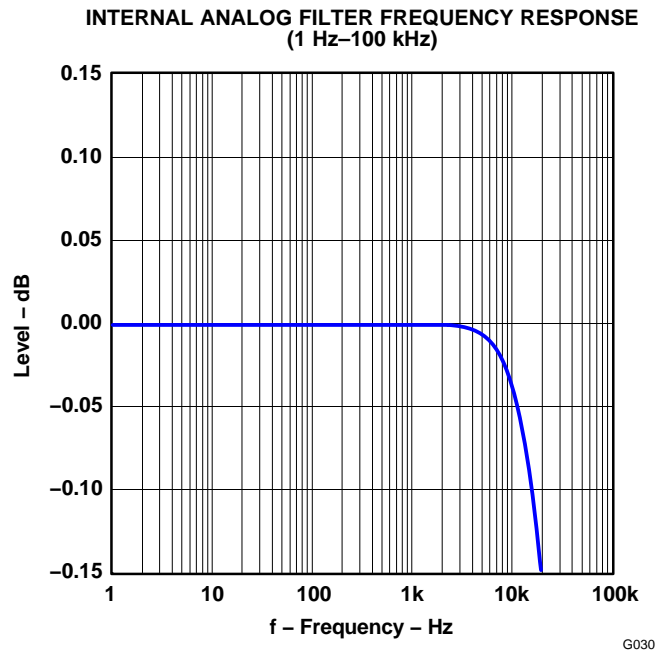
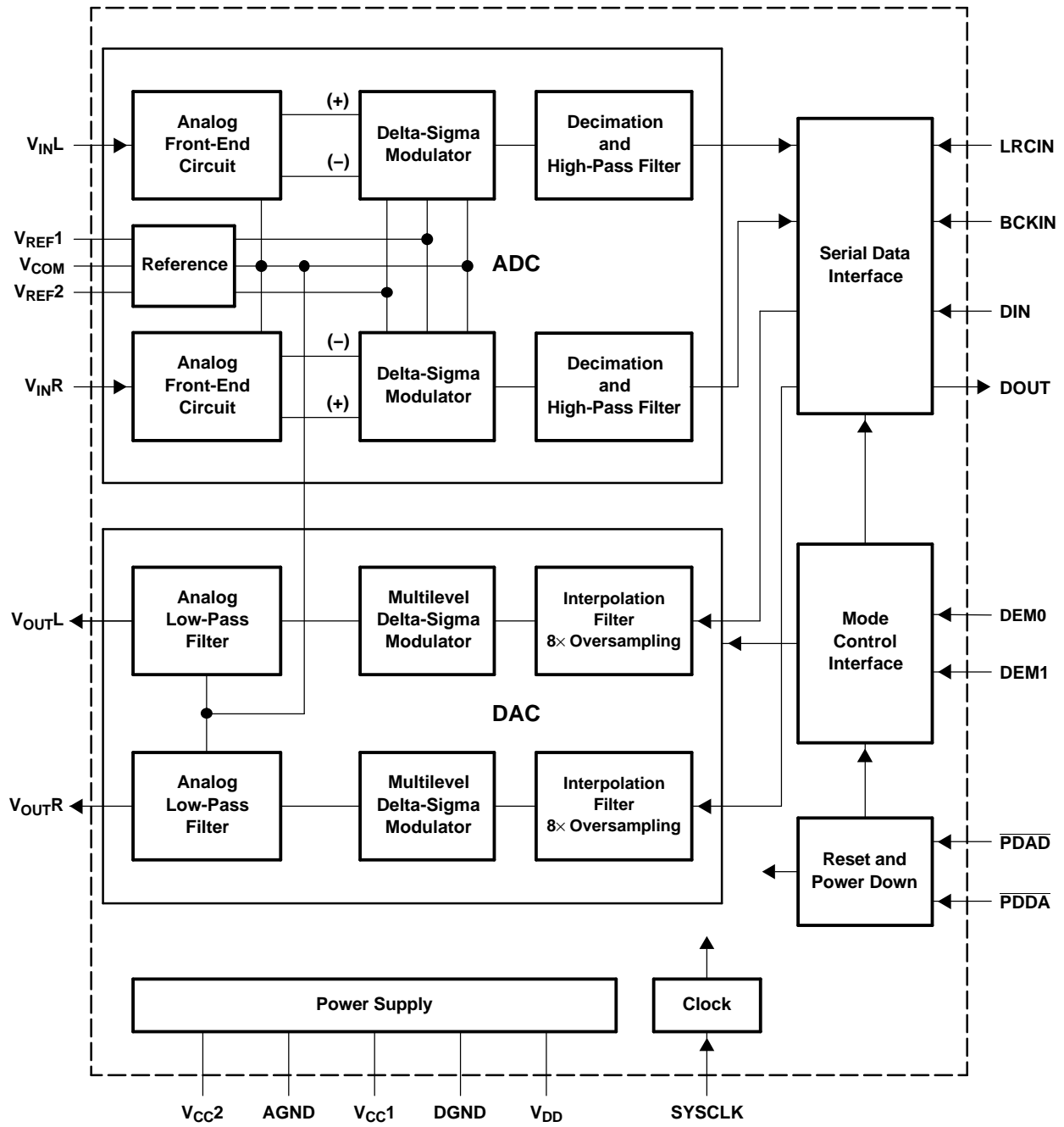
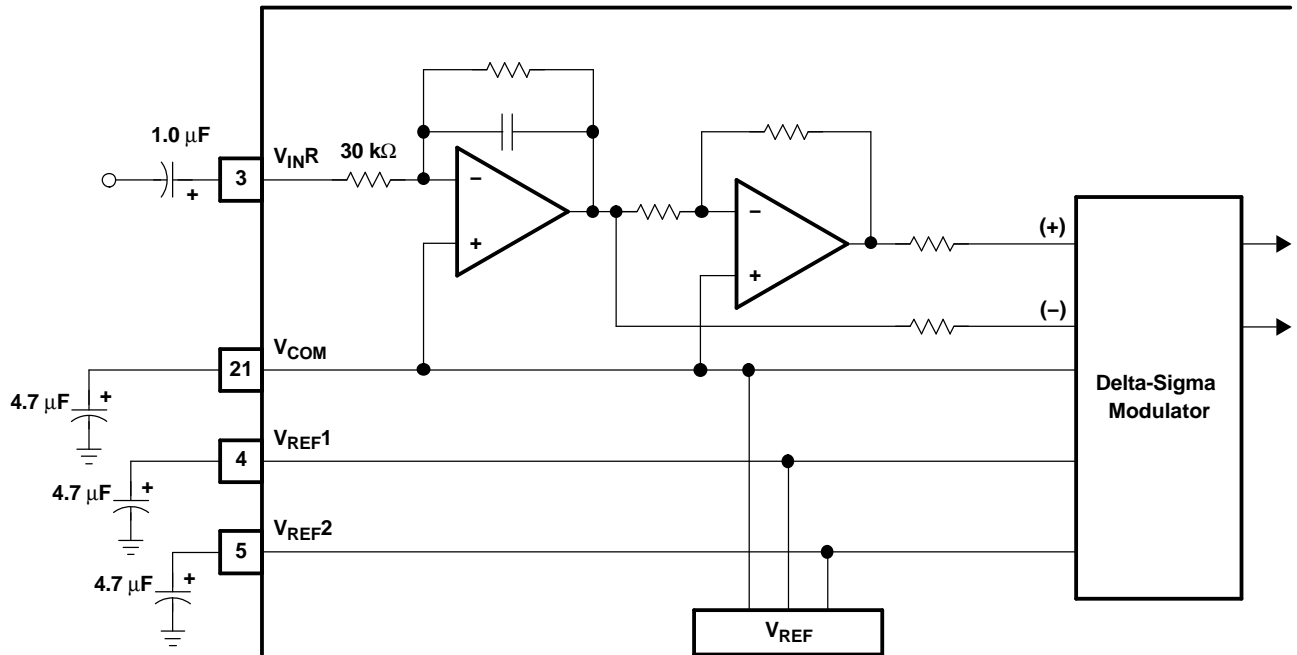

Figure 30.

BLOCK DIAGRAM



B0004-04



S0011-03

Figure 31. Analog Front End (Single-Channel)



## APPLICATION INFORMATION

### PCM AUDIO INTERFACE

The four-wire digital audio interface for the PCM3006 comprises LRCIN (pin 10), BCKIN (pin 11), DIN (pin 15), and DOUT (pin 12). The PCM3006 accepts 16-bit MSB-first, right-justified format for the DAC and 16-bit MSB-first, left-justified format for the ADC. The PCM3006 can accept 32, 48, or 64 bit clocks (BCKIN) in one clock of LRCIN. Figure 32 and Figure 33 illustrate audio data input/output format and timing.

#### FORMAT 0: PCM3006

DAC: 16-Bit, MSB-First, Right-Justified

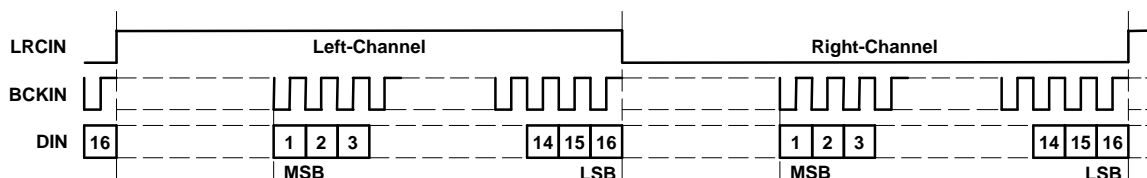

ADC: 16-Bit, MSB-First, Left-Justified

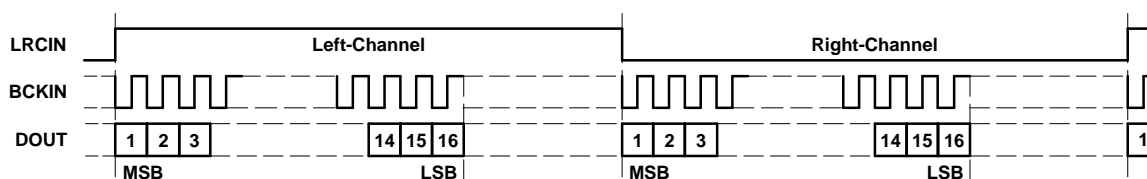

T0016-06

Figure 32. Audio Data Input/Output Format

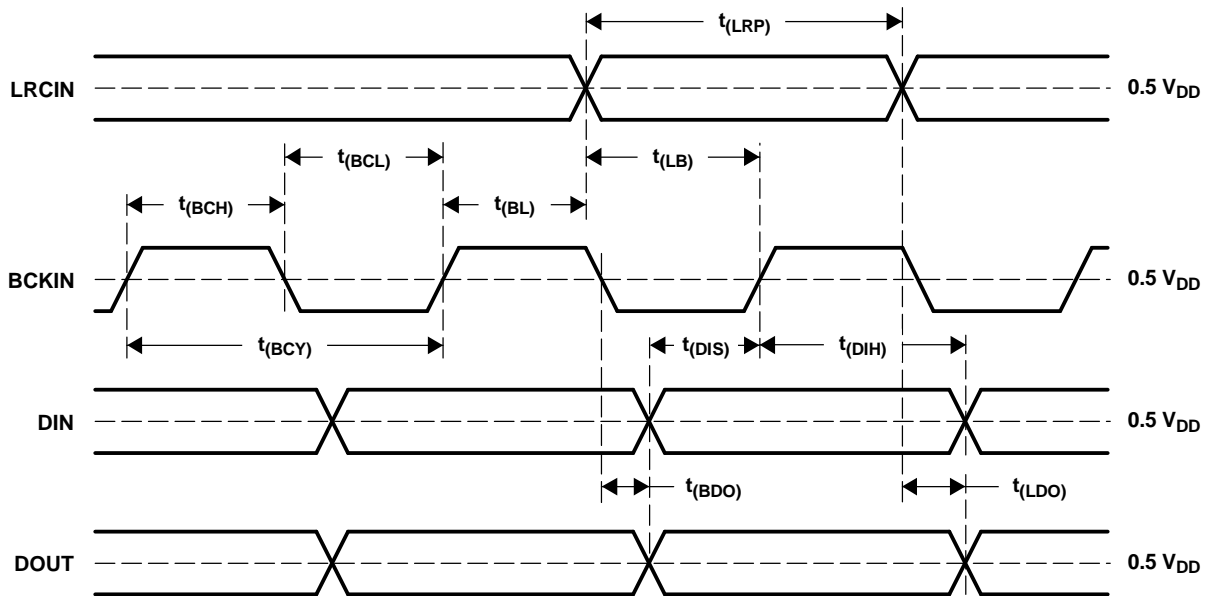

T0021–01

BCKIN pulse cycle time	$t_{(BCY)}$	300 ns (min)
BCKIN pulse duration, HIGH	$t_{(BCH)}$	120 ns (min)
BCKIN pulse duration, LOW	$t_{(BCL)}$	120 ns (min)
BCKIN rising edge to LRCIN edge	$t_{(BL)}$	40 ns (min)
LRCIN edge to BCKIN rising edge	$t_{(LB)}$	40 ns (min)
LRCIN pulse duration	$t_{(LRP)}$	$t_{(BCY)}$ (min)
DIN setup time	$t_{(DIS)}$	40 ns (min)
DIN hold time	$t_{(DIH)}$	40 ns (min)
DOUT delay time to BCKIN falling edge	$t_{(BDO)}$	40 ns (max)
DOUT delay time to LRCIN edge	$t_{(LDO)}$	40 ns (max)
Rising time of all signals	$t_{(RISE)}$	20 ns (max)
Falling time of all signals	$t_{(FALL)}$	20 ns (max)

Figure 33. Audio Data Input/Output Timing

## SYSTEM CLOCK

The system clock for the PCM3006 must be either  $256 f_s$ ,  $384 f_s$  or  $512 f_s$ , where  $f_s$  is the audio sampling frequency. The system clock should be provided to SYSCLK (pin 9).

The PCM3006 also has a system clock detection circuit that automatically senses if the system clock is operating at  $256 f_s$ ,  $384 f_s$ , or  $512 f_s$ . When a  $384 f_s$  or  $512 f_s$  system clock is used, the clock is divided into  $256 f_s$  automatically. The  $256 f_s$  clock is used to operate the digital filter and the delta-sigma modulator.

Table 1 lists the relationship of typical sampling frequencies and system clock frequencies, and Figure 34 illustrates the system clock timing.

Table 1. System Clock Frequencies

SAMPLING RATE FREQUENCY (kHz)	SYSTEM CLOCK FREQUENCY MHz		
	$256 f_s$	$384 f_s$	$512 f_s$
32	8.1920	12.2880	16.3840
44.1	11.2896	16.9344	22.5792
48	12.2880	18.4320	24.5760

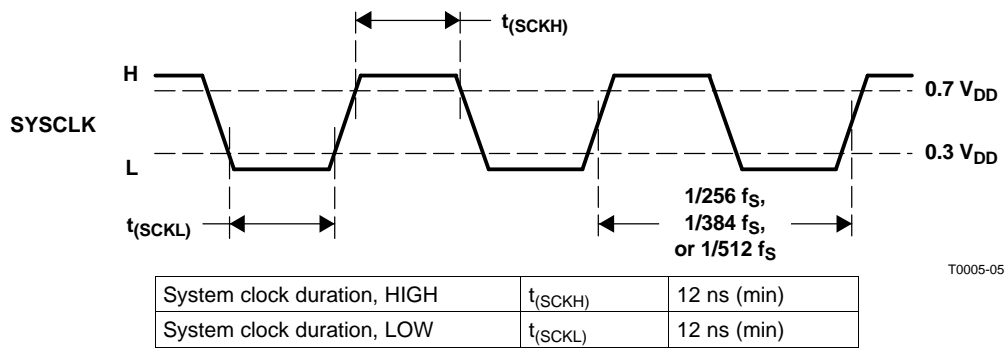

Figure 34. System Clock Timing

RESET

The PCM3006 has an internal power-on reset circuit, as well as an external forced reset. The internal power-on reset initializes (resets) when the supply voltage V<sub>DD</sub> > 2.2 V (typ). External forced reset occurs when PDAD = LOW and PDDA = LOW. Figure 35 shows the internal power-on reset timing and Figure 36 shows the external forced reset timing by PDAD and PDDA. During external forced reset, the outputs of the DAC are forced to GND (see Figure 37). The analog outputs are then forced to 0.5 V<sub>CC</sub> during t<sub>(DACDLY1)</sub> (16384/f<sub>S</sub>) after reset removal. The outputs of ADC are also invalid; digital outputs are forced to all zero during t<sub>(ADC DLY1)</sub> (18432/f<sub>S</sub>) after reset removal.

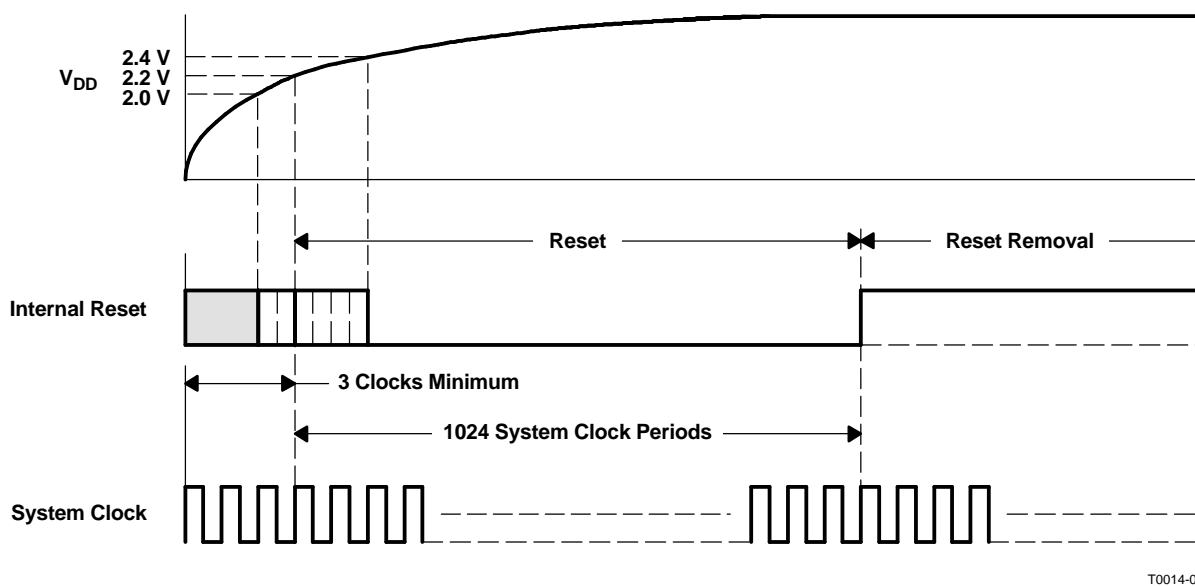
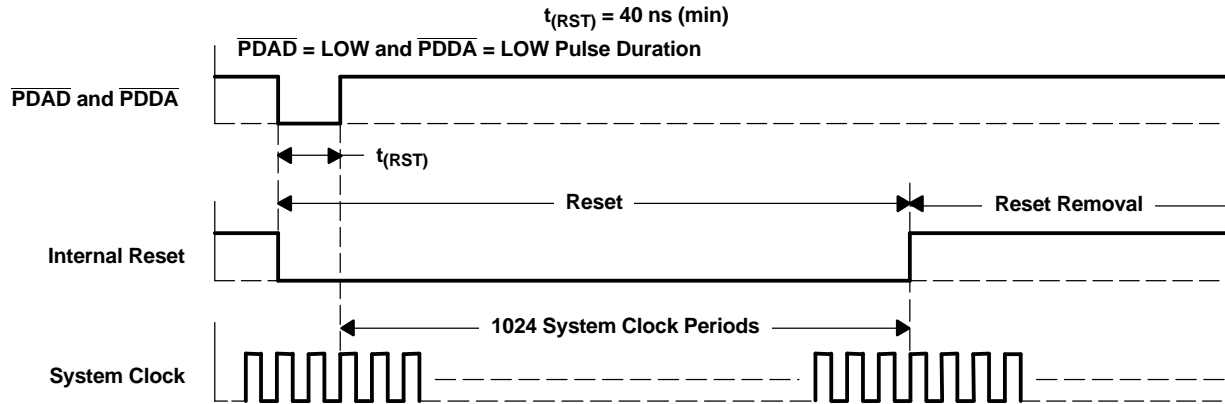
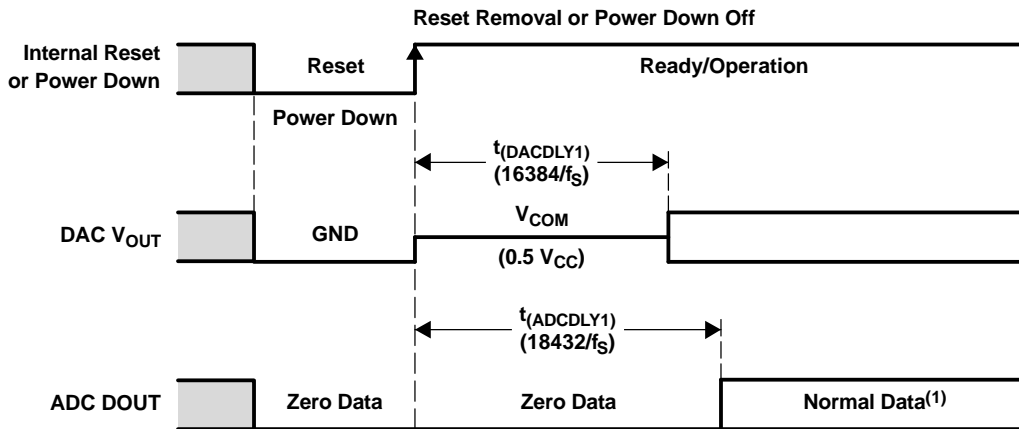

Figure 35. Internal Power-On Reset Timing



T0015-03

Figure 36. External Forced-Reset Timing



T0019-02

- (1) The HPF transient response (exponentially attenuated signal from  $\pm 0.2\%$  dc of FSR with 200-ms time constant) appears initially.

Figure 37. DAC Output and ADC Output for Reset and Power Down

### SYNCHRONIZATION WITH THE DIGITAL AUDIO SYSTEM

The PCM3006 operates with LRCIN synchronized to the system clock. The PCM3006 does not require any specific phase relationship between LRCIN and the system clock, but there must be synchronization of LRCIN and the system clock. If the relationship between the system clock and LRCIN changes more than 6 bit clocks (BCKIN) during one sample (LRCIN) period because of phase jitter on LRCIN, internal operation of the DAC stops within  $1/f_S$ , and the analog output is forced to bipolar zero ( $0.5 V_{CC}$ ) until  $t_{(DACDLY2)}$  delay time after the system clock is resynchronized to LRCIN. Internal operation of the ADC also stops within  $1/f_S$ , and the digital output codes are set to bipolar zero until  $t_{(DACDLY2)}$  delay time after resynchronization occurs. If LRCIN remains synchronized to the system clock within 5 or fewer bit clocks, operation is normal. Figure 38 illustrates the effects on the output when synchronization is lost. Before the outputs are forced to bipolar zero ( $< 1/f_S$  seconds), the outputs are not defined and some noise may occur. During the transitions between normal data and undefined states, the output has discontinuities, which cause output noise.

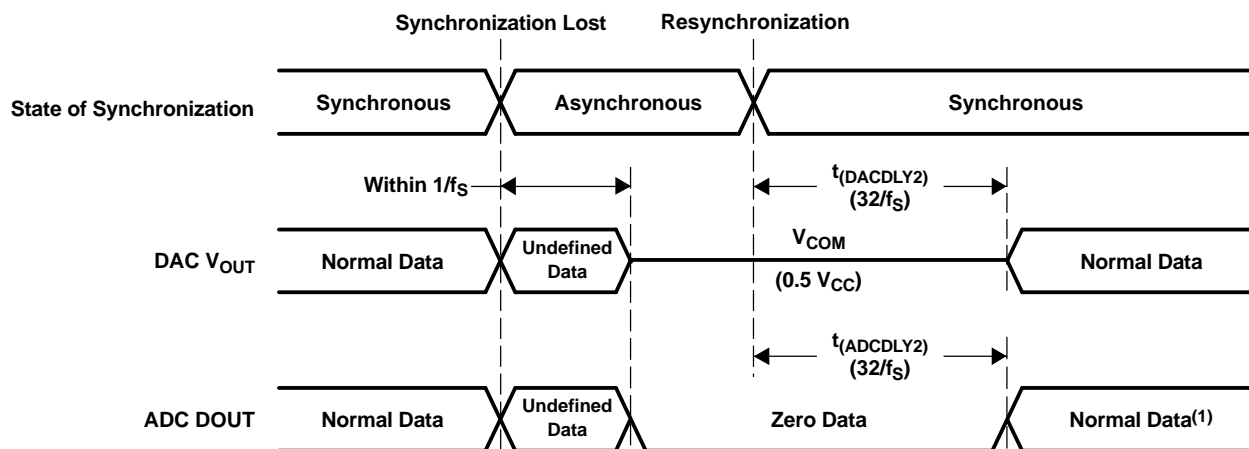

T0020-03

- (1) The HPF transient response (exponentially attenuated signal from  $\pm 0.2\%$  dc of FSR with 200-ms time constant) appears initially.

**Figure 38. DAC Output and ADC Output for Loss of Synchronization**

## OPERATIONAL CONTROL

The PCM3006 has hardware functional control using  $\overline{\text{PDAD}}$  (pin 7) and  $\overline{\text{PDDA}}$  (pin 8) for power-down control and DEM0 (pin 18) and DEM1 (pin 17) for de-emphasis.

### $\overline{\text{PDAD}}$ : ADC Power-Down Control (Pin 7)

This pin places the ADC section in the lowest power-consumption mode. The ADC operation is stopped by cutting the supply current to the ADC section, and DOUT is fixed to zero during ADC power-down-mode enable. Figure 37 illustrates the ADC DOUT response for ADC power-down ON/OFF. This does not affect the DAC operation.

$\overline{\text{PDAD}}$	POWER DOWN
Low	ADC power-down mode enabled
High	ADC power-down mode disabled

### $\overline{\text{PDDA}}$ : DAC Power-Down Control (Pin 8)

This pin places the DAC section in the lowest power-consumption mode. The DAC operation is stopped by cutting the supply current to the DAC section and VOUT is fixed to GND during DAC power-down-mode enable. Figure 37 illustrates the DAC VOUT response for DAC power-down ON/OFF. This does not affect the ADC operation.

$\overline{\text{PDDA}}$	POWER DOWN
Low	DAC power-down mode enabled
High	DAC power-down mode disabled

### DEM [1:0]: DAC De-Emphasis Control (Pin 17 and Pin 18)

These pins select the de-emphasis mode as shown below:

DEM1	DEM0	DE-EMPHASIS
Low	Low	De-emphasis 44.1 kHz ON
Low	High	De-emphasis OFF
High	Low	De-emphasis 48 kHz ON
High	High	De-emphasis 32 kHz ON

## APPLICATION AND LAYOUT CONSIDERATIONS

### POWER-SUPPLY BYPASSING

The digital and analog power supply lines to the PCM3006 should be bypassed to the corresponding ground pins with both 0.1- $\mu$ F ceramic and 10- $\mu$ F tantalum capacitors as close to the device pins as possible. Although the PCM3006 has three power supply lines to optimize dynamic performance, the use of one common power supply is generally recommended to avoid unexpected latch-up or pop noise due to power-supply sequencing problems. If separate power supplies are used, back-to-back diodes are recommended to avoid latch-up problems.

### GROUNDING

In order to optimize the dynamic performance of the PCM3006, the analog and digital grounds are not connected internally. The PCM3006 performance is optimized with a single ground plane for all returns. It is recommended to tie all PCM3006 ground pins to the analog ground plane using low-impedance connections. The PCM3006 should reside entirely over this plane to avoid coupling high-frequency digital switching noise into the analog ground plane.

### VOLTAGE INPUT

A tantalum capacitor, between 1  $\mu$ F and 10  $\mu$ F, is recommended as an ac-coupling capacitor at the inputs. Combined with the 30-k $\Omega$  characteristic input impedance, a 1- $\mu$ F coupling capacitor establishes a 5.3-Hz cutoff frequency for blocking dc. The input voltage range can be increased by adding a series resistor on the analog input line. This series resistor, when combined with the 30-k $\Omega$  input impedance, creates a voltage divider and enables larger input ranges.

### V<sub>REF</sub> INPUTS

A 4.7- $\mu$ F to 10- $\mu$ F tantalum capacitor is recommended between V<sub>REF1</sub>, V<sub>REF2</sub>, and AGND to ensure low source impedance for the ADC references. These capacitors should be located as close as possible to the reference pins to reduce dynamic errors on the ADC reference.

### V<sub>COM</sub> INPUT

A 4.7- $\mu$ F to 10- $\mu$ F tantalum capacitor is recommended between V<sub>COM</sub> and AGND to ensure low source impedance of the ADC and DAC common voltage. This capacitor should be located as close as possible to the V<sub>COM</sub> pin to reduce dynamic errors on the ADC and DAC common voltage.

### SYSTEM CLOCK

The quality of the system clock can influence dynamic performance of both the ADC and DAC in the PCM3006. The duty cycle and jitter at the system clock input pin should be carefully managed. When power is supplied to the part, the system clock, bit clock (BCKIN), and word clock (LCRIN) must also be supplied simultaneously. Failure to supply the audio clocks results in a power dissipation increase of up to three times normal dissipation and can degrade long-term reliability if the maximum power-dissipation limit is exceeded.

### RST CONTROL

If capacitors larger than 22  $\mu$ F are used between V<sub>REF</sub> and V<sub>COM</sub>, external reset control by  $\overline{\text{PDAD}} = \text{LOW}$  and  $\overline{\text{PDDA}} = \text{LOW}$  is required after the V<sub>REF</sub>, V<sub>COM</sub> transient response has settled.

### EXTERNAL MUTE CONTROL

Click noises are caused by dc level changes at the DAC output. To avoid any click noises going in and out of power-down mode, an external mute control is generally required. The recommended control sequence is as follows: external mute ON, codec power-down OFF, and then external mute OFF.

NOTE: If SYSCLK is stopped when the PCM3006 is in power-down mode, the device is internally reset.

### TYPICAL CONNECTION DIAGRAM

Figure 39 is a schematic diagram showing typical connections for the PCM3006.

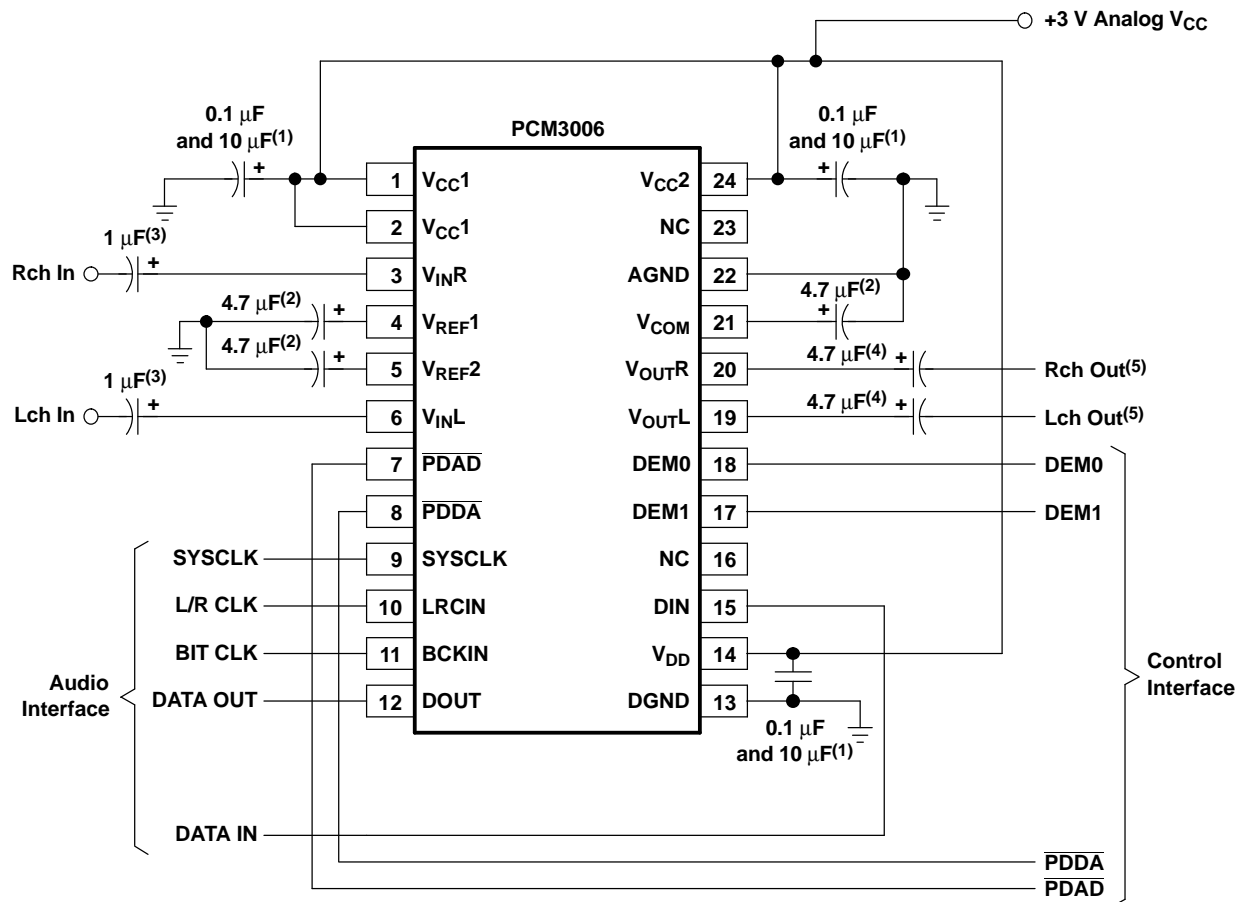

S0014-02

- (1) 0.1- $\mu$ F ceramic and 10- $\mu$ F tantalum, typical, depending on power supply quality and pattern layout
- (2) 4.7- $\mu$ F, typical, gives settling time with a 30-ms ( $4.7 \mu\text{F} \times 6.4 \text{ k}\Omega$ ) time constant in the power ON and power-down OFF periods.
- (3) 1- $\mu$ F, typical, gives a 5.3-Hz cutoff frequency for the input HPF in normal operation, and gives a settling time with a 30-ms ( $1 \mu\text{F} \times 30 \text{ k}\Omega$ ) time constant in the power ON and power-down OFF periods.
- (4) 4.7- $\mu$ F, typical, gives a 3.4-Hz cutoff frequency for the output HPF in normal operation, and gives a settling time with a 47-ms ( $4.7 \mu\text{F} \times 10 \text{ k}\Omega$ ) time constant in the power ON and power-down OFF periods.
- (5) Post low-pass filter with  $R_{IN} > 10 \text{ k}\Omega$ , depending on the system performance requirements

**Figure 39. Typical Connection Diagram for PCM3006**

## THEORY OF OPERATION

### ADC SECTION

The PCM3006 ADC consists of two reference circuits, a stereo single-to-differential converter, a fully differential 5-order delta-sigma modulator, a decimation filter (including digital high pass), and a serial interface circuit. The block diagram in this data sheet illustrates the architecture of the ADC section, Figure 31 shows the single-to-differential converter, and Figure 40 illustrates the architecture of the 5-order delta-sigma modulator and transfer functions.

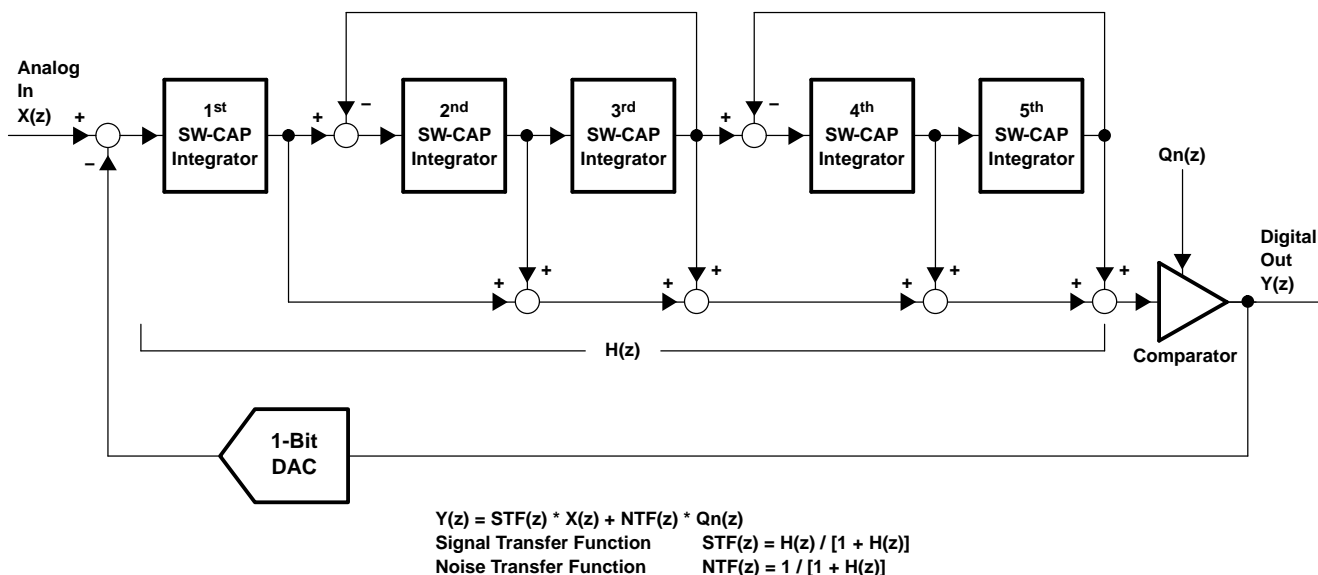

B0005-01

**Figure 40. Simplified 5-Order Delta-Sigma Modulator**

An internal reference circuit with three external capacitors provides all reference voltages that are required by the ADC, which defines the full-scale range for the converter. The internal single-to-differential voltage converter saves the design, space, and extra parts needed for the external circuitry required by many delta-sigma converters. The internal full-differential signal processing architecture provides wide dynamic range and excellent power-supply rejection performance. The input signal is sampled at  $64\times$  the oversampling rate, eliminating the need for a sample-and-hold circuit and simplifying antialias filtering requirements. The 5-order delta-sigma noise shaper consists of five integrators using switched-capacitor topology, a comparator, and a feedback loop consisting of a one-bit DAC. The delta-sigma modulator shapes the quantization noise, shifting it out of the audio band in the frequency domain. The high order of the modulator enables it to randomize the modulator outputs, reducing idle tone levels.

The  $64\text{-}f_s$  one-bit data stream from the modulator is converted to  $1\text{-}f_s$  16-bit data words by the decimation filter, which also acts as a low-pass filter to remove the shaped quantization noise. The dc components are removed by a high-pass filter function contained within the decimation filter.

### DAC SECTION

The delta-sigma DAC section of the PCM3006 is based on a 5-level amplitude quantizer and a third-order noise shaper. This section converts the oversampled input data to 5-level delta-sigma format. A block diagram of the 5-level delta-sigma modulator is shown in Figure 41. This 5-level delta-sigma modulator has the advantage of stability and clock-jitter sensitivity over the typical one-bit (2-level) delta-sigma modulator. The combined oversampling rate of the delta-sigma modulator and the internal  $8\times$  interpolation filter is  $64 f_s$  for a  $256\text{-}f_s$  system clock. The theoretical quantization noise performance of the 5-level delta-sigma modulator shown in Figure 42.



THEORY OF OPERATION (continued)

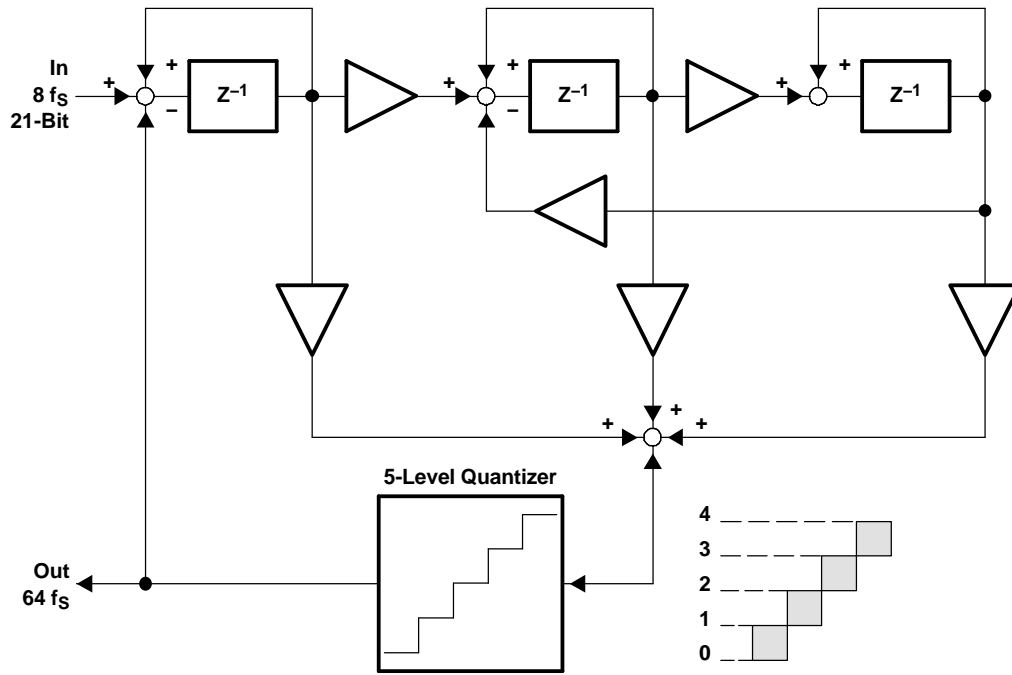

B0008-01

Figure 41. 5-Level  $\Delta\Sigma$  Modulator Block Diagram

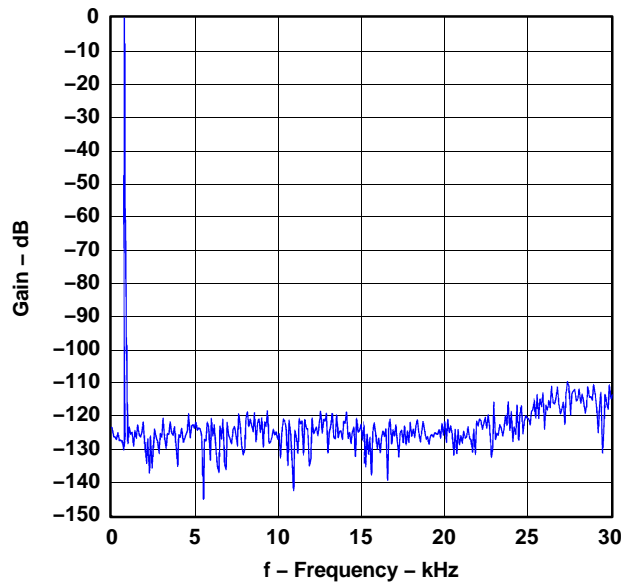

G031

Figure 42. Quantization Noise Spectrum

**PACKAGING INFORMATION**

Orderable Device	Status <sup>(1)</sup>	Package Type	Package Drawing	Pins	Package Qty	Eco Plan <sup>(2)</sup>	Lead/Ball Finish	MSL Peak Temp <sup>(3)</sup>
PCM3006T	ACTIVE	SSOP	DCV	24	128	Green (RoHS & no Sb/Br)	CU SNBI	Level-1-260C-UNLIM
PCM3006T/2K	ACTIVE	SSOP	DCV	24	2000	Green (RoHS & no Sb/Br)	CU SNBI	Level-1-260C-UNLIM
PCM3006T/2KG6	ACTIVE	SSOP	DCV	24	2000	Green (RoHS & no Sb/Br)	CU SNBI	Level-1-260C-UNLIM
PCM3006TG6	ACTIVE	SSOP	DCV	24	128	Green (RoHS & no Sb/Br)	CU SNBI	Level-1-260C-UNLIM

<sup>(1)</sup> The marketing status values are defined as follows:

**ACTIVE:** Product device recommended for new designs.

**LIFEBUY:** TI has announced that the device will be discontinued, and a lifetime-buy period is in effect.

**NRND:** Not recommended for new designs. Device is in production to support existing customers, but TI does not recommend using this part in a new design.

**PREVIEW:** Device has been announced but is not in production. Samples may or may not be available.

**OBSOLETE:** TI has discontinued the production of the device.

<sup>(2)</sup> Eco Plan - The planned eco-friendly classification: Pb-Free (RoHS), Pb-Free (RoHS Exempt), or Green (RoHS & no Sb/Br) - please check <http://www.ti.com/productcontent> for the latest availability information and additional product content details.

**TBD:** The Pb-Free/Green conversion plan has not been defined.

**Pb-Free (RoHS):** TI's terms "Lead-Free" or "Pb-Free" mean semiconductor products that are compatible with the current RoHS requirements for all 6 substances, including the requirement that lead not exceed 0.1% by weight in homogeneous materials. Where designed to be soldered at high temperatures, TI Pb-Free products are suitable for use in specified lead-free processes.

**Pb-Free (RoHS Exempt):** This component has a RoHS exemption for either 1) lead-based flip-chip solder bumps used between the die and package, or 2) lead-based die adhesive used between the die and leadframe. The component is otherwise considered Pb-Free (RoHS compatible) as defined above.

**Green (RoHS & no Sb/Br):** TI defines "Green" to mean Pb-Free (RoHS compatible), and free of Bromine (Br) and Antimony (Sb) based flame retardants (Br or Sb do not exceed 0.1% by weight in homogeneous material)

<sup>(3)</sup> MSL, Peak Temp. -- The Moisture Sensitivity Level rating according to the JEDEC industry standard classifications, and peak solder temperature.

**Important Information and Disclaimer:** The information provided on this page represents TI's knowledge and belief as of the date that it is provided. TI bases its knowledge and belief on information provided by third parties, and makes no representation or warranty as to the accuracy of such information. Efforts are underway to better integrate information from third parties. TI has taken and continues to take reasonable steps to provide representative and accurate information but may not have conducted destructive testing or chemical analysis on incoming materials and chemicals. TI and TI suppliers consider certain information to be proprietary, and thus CAS numbers and other limited information may not be available for release.

In no event shall TI's liability arising out of such information exceed the total purchase price of the TI part(s) at issue in this document sold by TI to Customer on an annual basis.

**TAPE AND REEL INFORMATION**



**QUADRANT ASSIGNMENTS FOR PIN 1 ORIENTATION IN TAPE**

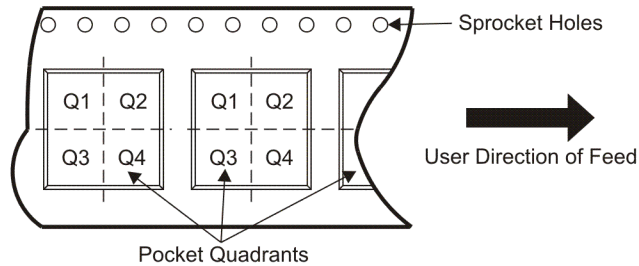

\*All dimensions are nominal

Device	Package Type	Package Drawing	Pins	SPQ	Reel Diameter (mm)	Reel Width W1 (mm)	A0 (mm)	B0 (mm)	K0 (mm)	P1 (mm)	W (mm)	Pin1 Quadrant
PCM3006T/2K	SSOP	DCV	24	2000	330.0	17.4	8.1	8.5	1.75	12.0	16.0	Q1

**TAPE AND REEL BOX DIMENSIONS**



\*All dimensions are nominal

Device	Package Type	Package Drawing	Pins	SPQ	Length (mm)	Width (mm)	Height (mm)
PCM3006T/2K	SSOP	DCV	24	2000	346.0	346.0	33.0

## DCV (R-PSOP-G24)

## PLASTIC SMALL-OUTLINE

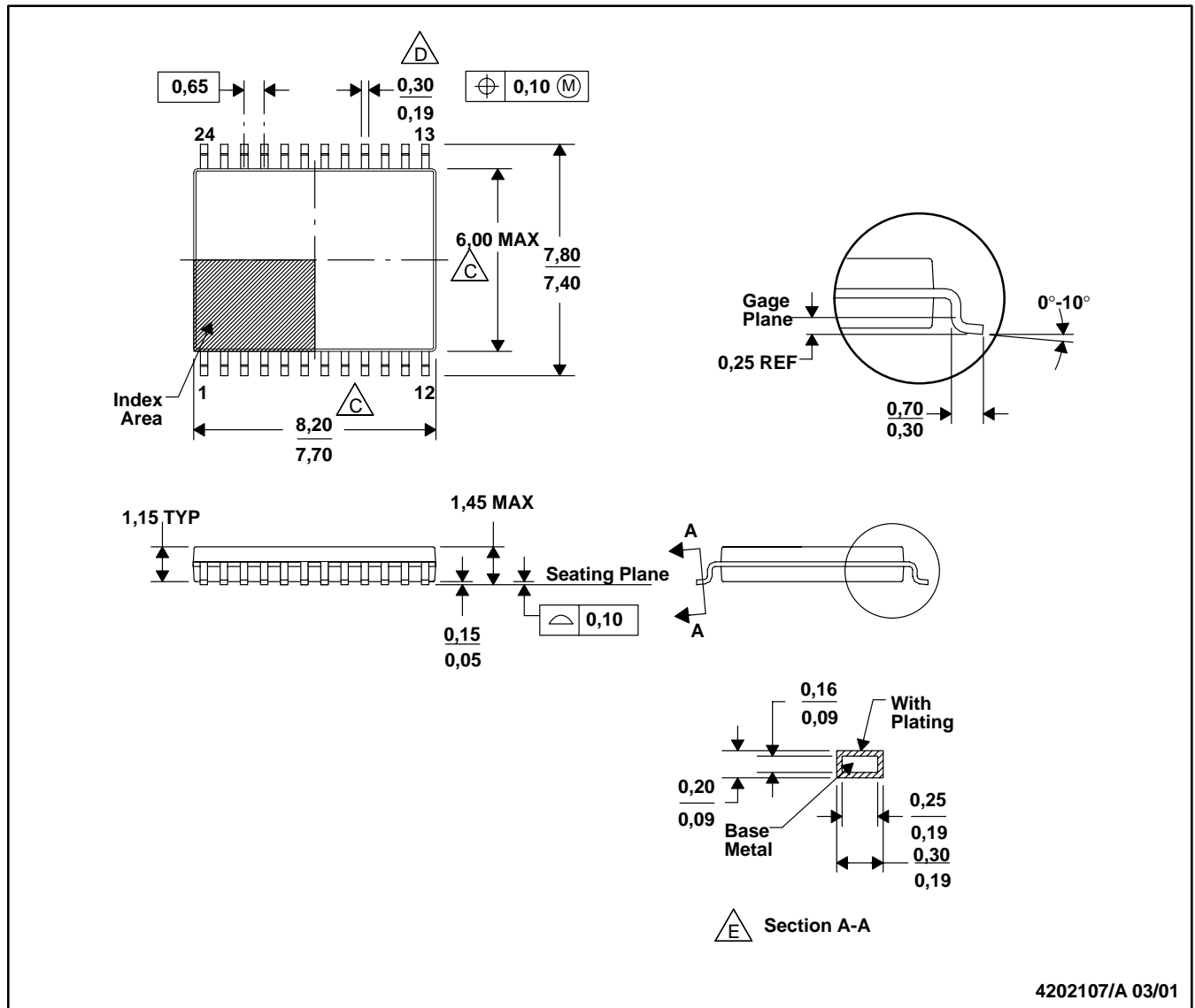

- NOTES:
- A. All linear dimensions are in millimeters.
  - B. This drawing is subject to change without notice.
  - C. Body dimensions do not include mold flash or protrusions, but do include mold mismatch and are measured at datum plane, mold parting line. Mold flash or protrusion shall not exceed 0,20mm per side.
  - D. Lead width dimension does not include dambar protrusion/ intrusion. Allowable dambar protrusion shall be 0,13mm total in excess of width dimension at maximum material condition. Dambar intrusion shall not reduce width dimension by more than 0,07mm at least material condition.
  - E. All dimensions in Section A-A apply to the flat section of the lead between 0,10mm and 0,25mm from the lead tips.
  - F. A visual index feature must be located within the cross-hatched area.

## IMPORTANT NOTICE

Texas Instruments Incorporated and its subsidiaries (TI) reserve the right to make corrections, modifications, enhancements, improvements, and other changes to its products and services at any time and to discontinue any product or service without notice. Customers should obtain the latest relevant information before placing orders and should verify that such information is current and complete. All products are sold subject to TI's terms and conditions of sale supplied at the time of order acknowledgment.

TI warrants performance of its hardware products to the specifications applicable at the time of sale in accordance with TI's standard warranty. Testing and other quality control techniques are used to the extent TI deems necessary to support this warranty. Except where mandated by government requirements, testing of all parameters of each product is not necessarily performed.

TI assumes no liability for applications assistance or customer product design. Customers are responsible for their products and applications using TI components. To minimize the risks associated with customer products and applications, customers should provide adequate design and operating safeguards.

TI does not warrant or represent that any license, either express or implied, is granted under any TI patent right, copyright, mask work right, or other TI intellectual property right relating to any combination, machine, or process in which TI products or services are used. Information published by TI regarding third-party products or services does not constitute a license from TI to use such products or services or a warranty or endorsement thereof. Use of such information may require a license from a third party under the patents or other intellectual property of the third party, or a license from TI under the patents or other intellectual property of TI.

Reproduction of TI information in TI data books or data sheets is permissible only if reproduction is without alteration and is accompanied by all associated warranties, conditions, limitations, and notices. Reproduction of this information with alteration is an unfair and deceptive business practice. TI is not responsible or liable for such altered documentation. Information of third parties may be subject to additional restrictions.

Resale of TI products or services with statements different from or beyond the parameters stated by TI for that product or service voids all express and any implied warranties for the associated TI product or service and is an unfair and deceptive business practice. TI is not responsible or liable for any such statements.

TI products are not authorized for use in safety-critical applications (such as life support) where a failure of the TI product would reasonably be expected to cause severe personal injury or death, unless officers of the parties have executed an agreement specifically governing such use. Buyers represent that they have all necessary expertise in the safety and regulatory ramifications of their applications, and acknowledge and agree that they are solely responsible for all legal, regulatory and safety-related requirements concerning their products and any use of TI products in such safety-critical applications, notwithstanding any applications-related information or support that may be provided by TI. Further, Buyers must fully indemnify TI and its representatives against any damages arising out of the use of TI products in such safety-critical applications.

TI products are neither designed nor intended for use in military/aerospace applications or environments unless the TI products are specifically designated by TI as military-grade or "enhanced plastic." Only products designated by TI as military-grade meet military specifications. Buyers acknowledge and agree that any such use of TI products which TI has not designated as military-grade is solely at the Buyer's risk, and that they are solely responsible for compliance with all legal and regulatory requirements in connection with such use.

TI products are neither designed nor intended for use in automotive applications or environments unless the specific TI products are designated by TI as compliant with ISO/TS 16949 requirements. Buyers acknowledge and agree that, if they use any non-designated products in automotive applications, TI will not be responsible for any failure to meet such requirements.

Following are URLs where you can obtain information on other Texas Instruments products and application solutions:

### Products

Amplifiers	<a href="http://amplifier.ti.com">amplifier.ti.com</a>
Data Converters	<a href="http://dataconverter.ti.com">dataconverter.ti.com</a>
DSP	<a href="http://dsp.ti.com">dsp.ti.com</a>
Clocks and Timers	<a href="http://www.ti.com/clocks">www.ti.com/clocks</a>
Interface	<a href="http://interface.ti.com">interface.ti.com</a>
Logic	<a href="http://logic.ti.com">logic.ti.com</a>
Power Mgmt	<a href="http://power.ti.com">power.ti.com</a>
Microcontrollers	<a href="http://microcontroller.ti.com">microcontroller.ti.com</a>
RFID	<a href="http://www.ti-rfid.com">www.ti-rfid.com</a>
RF/IF and ZigBee® Solutions	<a href="http://www.ti.com/lprf">www.ti.com/lprf</a>

### Applications

Audio	<a href="http://www.ti.com/audio">www.ti.com/audio</a>
Automotive	<a href="http://www.ti.com/automotive">www.ti.com/automotive</a>
Broadband	<a href="http://www.ti.com/broadband">www.ti.com/broadband</a>
Digital Control	<a href="http://www.ti.com/digitalcontrol">www.ti.com/digitalcontrol</a>
Medical	<a href="http://www.ti.com/medical">www.ti.com/medical</a>
Military	<a href="http://www.ti.com/military">www.ti.com/military</a>
Optical Networking	<a href="http://www.ti.com/opticalnetwork">www.ti.com/opticalnetwork</a>
Security	<a href="http://www.ti.com/security">www.ti.com/security</a>
Telephony	<a href="http://www.ti.com/telephony">www.ti.com/telephony</a>
Video & Imaging	<a href="http://www.ti.com/video">www.ti.com/video</a>
Wireless	<a href="http://www.ti.com/wireless">www.ti.com/wireless</a>

Mailing Address: Texas Instruments, Post Office Box 655303, Dallas, Texas 75265  
Copyright © 2008, Texas Instruments Incorporated